

mvs 
IN
MOTION

Resistive • Hand • Upper & lower body
• Wellness • Fitness • Strength
• Thermal • Evaluation • ADL



2024-2025

Catalogue

Preface

Dear Customer

We proudly present our new catalogue to you. That is right, MVS In Motion is in a new jacket! Together, we will unwrap our new branding for the coming years on Medica Trade Fair 2023. This move follows the further growth to professionalism and will help us to enlarge our brand awareness in the world of physiotherapy and rehabilitation.

The birth of this new catalogue goes hand in hand with the move to our new offices in Roeselare. Our new offices are the closure of a year filled with construction and tight deadlines. We would also like to invite you, as our customers, to stop by and visit us at our new location. We are delighted to show you our new work environment, our professional showroom and dynamic team.

In order to keep up pace with the fast global changes, we once again have some new products to present to you. Check out our novelties section on page 14 to discover them all.

Of course, all of this would not be possible without you and without our fantastic team. A special thanks to everyone associated with MVS In Motion.

The next step will be the transformation of our website, which will have the same branding as the catalogue. Just bear with us a moment longer, we will inform you about the launch soon.

We kindly invite you to pay us a visit at our booth at Medica 2023 and Arab Health 2024 to celebrate our complete transformation. Let's flip the page together to a new era of MVS In Motion.

Together, we will stretch our limits, fiercely and with a lot of fun!

Sincerely yours,

Evelyn and Tom

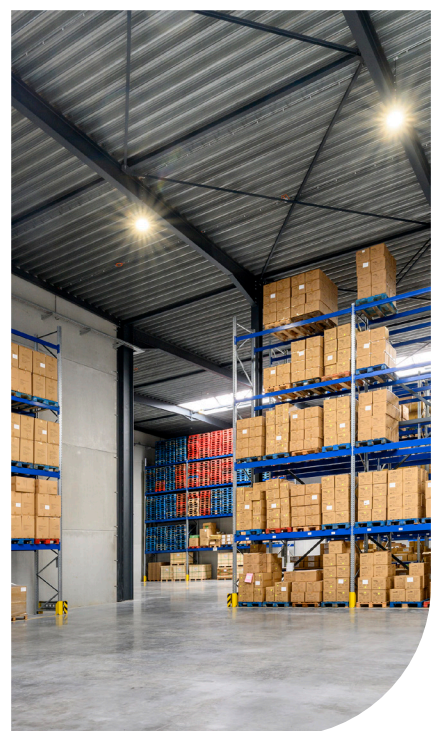

Table of contents

2	Preface
3	Table of contents
7	Brands
9	MVS In Motion
11	Moves
13	Mambo Max
14	New products
17	O1 Resistive
20	Moves band
21	Moves latex-free band
22	Moves tube
23	Moves wide loop
	Moves loop
24	Moves fabric elastic loops
26	Moves FIT band
26	Moves FIT tube
27	Moves FIT loop
	Moves FIT superloop
28	Moves bar
	Moves ring tube
29	Moves ankleciser
30	Moves shoulder rope pulley
	Door anchor notch handles
	Door anchor wooden handles
	Door anchor hand support
	Metal bracket
31	Value pack
	Moves shoulder tube pulley
	Moves knee rope pulley
32	Moves accessories
33	O2 Hand
34	Moves Flex-Ion
35	Digi-Flex®
	Digi-Extend®
36	Handmaster Plus™
	Prohands® series
37	VariGrip Therapy
	VariGrip Sport
	Constant Force X-Tend
38	Power-Web® Combo
	Power-Web® Senior
	Power-Web® Junior
39	Power-Web® Flex-Grip
	Adjustable hand grip
	Foam hand grip
40	Moves squeeze balls & eggs
	Moves wrist exerciser
41	Moves comfort putty
42	Theraflex™ putty
43	Therapie Sand

44

45
46
47
48
49
50
51

O3 Upper & lower body

Moves oxycycle 1 - active magnetic
Moves oxycycle 2 - passive
Moves oxycycle 3 - active & passive
Moves oxycycle pedals
CuraMotion
Moves foldable pedal exerciser
Moves standard pedal exerciser | premium chrome
Moves standard pedal exerciser K/D
Moves Cycle
Mambo Max ElliptiStep
Mambo Max fit stretch
Moves Wooden incline board
 Moves wooden incline board - fix
Mambo Max adjustable wooden incline board
Plastic incline board

52

53
54
56
57
58
59
61
62
63

O4 Wellness

Moves mini massage gun
Triggerpoint rollers
Moves IASTM tools
Massage tools
Massage ball, roll & ring
Sport tape
Kinesiology tape
Sitting cushions
Adjustable ball chair
Pilates
 Foam Roller
 Soft-Over-Ball
 Ring
Stepping stones
Yoga

64

65
66
67
68
69
70
71
72

O5 Fitness

Gym mat
Aerobic step
Fabric elastic band
Balance board
Wooden balance board
Balance board freeman
Body twister
Ekilibre
Balance trainer
Balance pad
Balance pad pro
AB gym ball
AB peanut ball
Dynadome
Ball accessories

73

74
75
76

O6 Strength

SoftMeds
Coated dumbbells
Medicine ball
Kettlebell
Wrist & ankle weights
Premium wrist & ankle weights

Thumb lock wrist weight

77

78

79

80

81

O7 Thermal

Para Pro - paraffin bath

Moist heat therapy by Moves

Hot/cold pack

PearlPack

PearlPack knee/elbow

PearlPack eye mask

PearlPack back wrap

PearlPack sports pack + strap

82

Roll-on pack

83

Instant Heat Pack

84

85

MicroFET@2 muscle test dynamometer

Fingertip pulse oximeter

Junior oximeter

Senior oximeter

86

Blood pressure monitor

Infrared thermometer

Ear & forehead thermometer

Shotgun thermometer

87

Pedi-scoliometer

Neurological reflex instruments

88

89

Hydraulic hand dynamometer

Hydraulic 3-piece hand evaluation kit

Hydraulic 7-piece hand evaluation kit

90

Digital hand dynamometer with data transfer software - DHD-1

Digital hand dynamometer with G-STAR™ software - DHD-3

Squeeze dynamometer

91

Smedley hand dynamometer

Back-leg-chest dynamometer

Pinch gauge

92

Plastic goniometer

Stainless steel goniometer

93

Finger goniometer

Goniometer kit

Tuning fork

94

Fat caliper

95

96

BIMS™ digital (Load-Cell) 5-position dynamometers

Functional model

Clinic model

Deluxe model

98

5-position hydraulic hand grip dynamometers

Pneumatic squeeze dynamometers

99

Smedley spring dynamometer

Electronic Smedley dynamometer

Mechanical pinch gauge

100

Hydraulic pinch gauge

5-position hydraulic pinch gauge

Electronic pinch gauge

101

7-piece hand sets

102

3-piece hand sets

103	Monitor exercise feedback device Push-pull dynamometer Back-leg-chest dynamometer
104	Finger (digit) goniometer Plastic finger goniometer 180° 20 cm goniometer 180° 35 cm goniometer 360° 35 cm goniometer
105	180° finger (small joint) goniometer 6-piece goniometer set XTender® extendable goniometer
106	Lafayette goniometer Plastic goniometers
107	Digital goniometer Touch-Test® 2-point discriminator Discrim-A-Gon® 2-point discriminator 2-point discriminators
108	Sit 'n Reach® box test Finger flexion gauge Gulick measurement tape Finger circumference gauge Circumference tape
109	Clinical monofilament sensory evaluators
110	Tuning Forks Pinwheel
111	Bubble® inclinometer AcuAngle® inclinometers Digital inclinometer Scoliometer
112	Economy skinfold caliper Skinfold calipers BMI body fat scale
113	15 ADL aids for daily living
114	StayPut®
115	UpCup
116	Beat It!
117	Theomatik®
118	Private label
120	After-sales
122	Terms & conditions

Brands

Our own brands



Master distributor for





MVS In Motion is a dynamic and quality-driven B2B company, with people dedicated to excellence in everything they do. We're a master distributor, specializing in physiotherapy, rehabilitation, sports, and fitness products. In 2021 the company was acquired by the new owners, Evelyn Deceuninck and Tom Vanhecke.

In 2023 we relocated to Roeselare (Belgium). True to our character, we completely reinvented ourselves. Now, we can proudly present the new and improved MVS In Motion.



... EXPERTISE

MVS In Motion is that one-stop shop that helps you to grow and succeed. Apart from offering valuable products, we support our customers with unique knowledge and expertise. Our basis is a good structure and well-oiled organization that efficiently responds to every question.



... DARING

MVS In Motion is constantly looking out for interesting and relevant opportunities. We do this to keep up with the market needs.



... INSIGHT

Insight into your needs and wishes is crucial. That is why we keep improving our wide range of products. We are energetic, powerful, and we like to tackle anything head-on.



... PASSION

We make a difference through our passion. MVS In Motion is committed and does not give up. We are continuously taking steps to deliver the best.



... VIBRANT

Innovating, evolving, and excelling is in our DNA. We are constantly on the move and we bring out the best in ourselves as well as in our customers. We are vibrant and encouraging, thanks to the solid foundation and the strong MVS team. You can always rely on us.

moves 



STRETCHING LIMITS

Moves is one of the own brands of MVS In Motion. It is a top-notch brand for people who want honest and terrific products. Moves helps you to become a better version of yourself. It helps you to stretch your limits.

Under the Moves brand, we also offer Moves FIT products. These products have a unique colour sequence which distinguishes us from the known colours available on the market.

... **ESSENCE**

Moves is there for you. Our focus and high standards is what makes us able to assist you with essential products and specific expertise.

... **HONEST**

We are ready for each and every request for help. We deliberately opt for a wide but specialised product range. These products have long proven their worth. Honest products that excel in quality and convenience.

... **EXPERTISE**

Moves stands for expertise and professional know-how. A quality-driven brand that guarantees optimal support. Moves products help during your rehabilitation or movement optimization. They help you to achieve your goals and succeed.

... **EVOLUTION**

With the aid of Moves, you move forward, step by step, towards your desired progression.

There are products for every phase, for every treatment. Moves is there to assist your evolution. You can bring your patient to the next level. With Moves, we help you to reach the top.

... **MEANINGFUL**

Moves keeps reinventing and improving its products. This brand has the ambition to do better each time. Moves makes the difference. We offer the best selection of products, that supports and eases the commitment and discipline of your patients.

mambo **Fit.
Fun.
Fierce.**
max





Mambo Max is the other brand of MVS In Motion. It's a light-hearted and fun brand that assists anyone in exercising with joy. Mambo Max lights the fire to become a healthier and happier version of yourself. Get fit, become fierce, but most importantly: have a lot of fun!

 ... **ENERGY**

Mambo Max brings balance into your life. This brand inspires you to take action, to work out, to move. It even assists you in relaxation and massage. It is the perfect partner for a healthy life.

 ... **FIT**

A body that is in shape, is a healthy body. Mambo Max offers a complete assortment to keep your body fit. It helps you to build power, resilience, flexibility, and balance. Together with Mambo Max, you move forward, with the right balance.

 ... **FUN**

Mambo Max is a symbol for fun. Our colourful range of products emphasises this. The goal is to give you that optimal, fun workout. Exercising becomes a true pleasure. You have to admit, working on yourself doesn't have to feel like working, does it?

 ... **ATTRACTIVE**

Mambo Max is here for everyone. Young and old, skilled or newbie, for people that want to see results. We make sports and exercising attractive. The happy and appealing colours guarantee a light-hearted, playful range.

New products

moves

Moves cycle

MD CE

The Moves Cycle pedal exerciser helps prevent, reduce, and improve the effects of immobility. It is mainly used for conditions such as neuromuscular, orthopedic, cardiovascular, and metabolic disorders, as well as other medical conditions that limit movement or cause bed confinement. Thanks to its durable and high-grade design, this active-passive exerciser can operate non-stop for ample hours!

Reference code	Description	Unit
O3-070101	Moves Cycle (active & passive trainer)	1 pc



mambo
max

ElliptiStep

CE

The Mambo Max ElliptiStep is an electromagnetic under-desk elliptical trainer. This compact and portable device is used for low-impact cardiovascular exercise while sitting. The ElliptiStep enhances your lower body strength and flexibility while tackling sedentary behavior. Specifically targeting users at home or at work.

Reference code	Description	Unit
O3-070150	Mambo Max ElliptiStep	1 pc



MAMBO MAX ELLIPTISTEP



MOVES CYCLE

Moist heat therapy by Moves CE

Constructed of seamless, stainless steel, a moist heat unit is a stationary or mobile thermostatically controlled liquid heating device. Once heat packs are inserted into the water inside, the unit heats them up to maximum 76°C. From here, the health professional removes the pack to wrap it in a cover (or towels) and applies it to the area being treated. The packs themselves draw in the heat to hold their temperature. This treatment assists with pain management, addressing spasms, improving a patient’s range of motion and loosening tight, contracted muscles before a massage, physical therapy or athletic training session or chiropractic adjustment.

MOIST HEAT PACK UNITS

We offer 4, 6 and 12-pack unit capacity, each made from durable, seamless, stainless steel.

MOIST HEAT PACKS

Easy-to-heat-up packs that retain moist heat for up to 30 minutes. They’re reusable and can be used with a cover or a towel.

MOIST HEAT PACK COVERS

We also offer moist heat pack covers, to cover a hot pack. These are reusable and washable.



HEATING UNIT | 6-PACK CAPACITY



STANDARD COVER

Reference code	Description	Unit
07-200101	Relief Pak by Moves heating unit 4-pack stationary w/o packs 220V	1 pc
07-200102	Relief Pak by Moves heating unit 6-pack stationary w/o packs 220V	1 pc
07-200103	Relief Pak by Moves heating unit 12-pack mobile w/o packs 220V	1 pc
07-200201	Moves Moist heat pack standard 25 x 30cm	1 pc
07-200202	Moves Moist heat pack neck 60 cm	1 pc
07-200203	Moves Moist heat pack spine small 25 x 45cm	1 pc
07-200301	Moves Moist heat pack cover standard (for standard and spine small)	1 pc
07-200302	Moves Moist heat pack cover cervical (for neck)	1 pc

ADL: StayPut®



Slips and falls are common accidents leading to anything from minor bruises to serious injuries like fractures. However, these incidents can be reduced with StayPut®, a non-slip material that provides better stability and grip across various settings.

This versatile, non-slip material grips on both sides, which makes it ideal for creating safer environments at home, in workplaces, and healthcare facilities. It prevents rolling, slipping, and sliding, making it perfect for keeping objects steady and improving safety for individuals. StayPut® features superior grip strength, holding items firmly on flat or uneven surfaces, including those subject to tipping or movement. Its rubberized, durable texture enhances stability for individuals walking or standing on it.

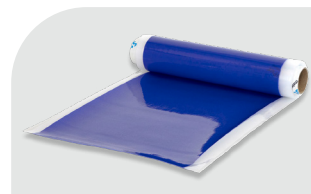

AVAILABLE IN 4 DIFFERENT SIZES

Colour	Reference code	Description	Unit
●	15-O1O1O1	StayPut non-slip material 20 cm x 180 cm	1 pc
	15-O1O1O2	StayPut non-slip material 20 cm x 925 cm	1 pc
	15-O1O2O1	StayPut non-slip material 40 cm x 180 cm	1 pc
	15-O1O2O2	StayPut non-slip material 40 cm x 925 cm	1 pc

ADL: UpCup

The UpCup is an **innovative drinking cup** specifically designed for the elderly, individuals with disabilities, those with strength, coordination, or swallowing difficulties, and people who struggle with independent drinking. The stable base and comfortable handles help those with difficulty gripping or swallowing drinks more easily and confidently. That way, the UpCup helps users regain their independence while enjoying their favorite beverages.

Reference code	Description	Unit	i
15-O5O1O1	UpCup	1 pc	

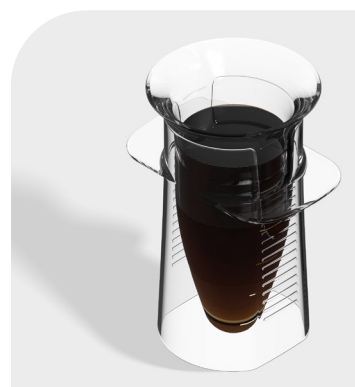

ADL: Beat It!

The Beat It is an innovative tool, specially designed for seniors, people with disabilities, impairments, or permanent injuries. It is a **multifunctional clamp** that allows you to easily secure various items such as cups, cans, jars, bottles, and drinking containers of all kinds. No more instability or items tipping over!

Reference code	Description	Unit	i
15-O5O1O2	Beat It	1 pc	



SLIDING MECHANISM LOCKED WITH PRODUCT

ADL: Theomatik®

Theomatik® is an innovative tool designed to **help people who can only use one arm eat independently**, both at home and on the go. Allowing people to eat without assistance boosts their independence and self-esteem, making the process easier and more enjoyable.

The product is designed with an ergonomic focus to stimulate fine motor skills, which is essential for older adults and those in rehabilitation. Its tactile and sensory features are important, and the orange color was chosen for its visual support for people with visual impairments or dementia.

Reference code	Description	Unit	i
15-O5O1O3	Theomatik	1 pc	

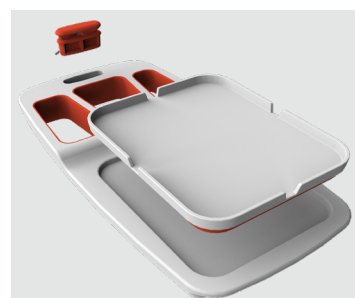

O1 Resistive



One-stop-shop for all your bands and tubes

MVS In Motion is your one-stop-shop for all resistive exercise products. With our premium quality brand Moves, we offer both original colour and FIT colour sequence products. In addition, we offer a wide range of Latex-Free resistive exercise bands in original colours. Our tubes and loops are also available in the original and FIT colour sequence.

The latex bands, tubes and (super)loops are made of high quality latex from huge rubber tree plantations in Malaysia. All products have an extraordinary elasticity and linearity. They are the ideal partner for your physiotherapy trainings or intensive work-outs, because:

- ✓ our bands have the patented Snap-Stop® feature
- ✓ our tubes go through a dipped production process
- ✓ our (super)loops are equipped with a multi-layered structure

The different resistances allow you to use Moves and Moves FIT products for rehabilitation as well as for fitness purposes.

Moves Latex-Free is made from TPE, with the same high quality standards as the regular Moves bands. Never before were the characteristics from Latex-Free bands so close to those from their latex counterpart.

- ✓ **Moves Band:** 8 resistances (Tan - Gold) & 5 lengths (1,5m - 2,5m - 5,5m - 22,5m - 45,5m)
- ✓ **Moves FIT Band:** 6 resistances (Peach - Grey) & 4 lengths (1,5m - 2,5m - 5,5m - 45,5m)
- ✓ **Moves Latex-Free Band:** 5 resistances (Yellow - Black) & 3 lengths (1,5m - 5,5m - 45,5m)

Original colours	Same resistance	FIT colours
 Tan Extra light	Same resistance	 Peach Light
 Yellow Light		 Orange Medium
 Red Medium		 Lime green Heavy
 Green Heavy		 Blueberry Extra heavy
 Blue Extra heavy		 Plum Special heavy
 Black Special heavy		 Grey Super Heavy
 Silver Super heavy		
 Gold Ultra heavy		

- Well-known colours used by physiotherapists all over the world
- Moves brings premium quality at an affordable price range

- FIT colours are more trendy and youthful than the original colours
- Sell Moves FIT next to Moves to widen customer base and generate more sales



What is Snap-Stop®?

Moves and Moves FIT Bands are unique in their field. Thanks to our extensive research and development, we have achieved an innovative production process: **the Snap-Stop® technology**. This distinctive feature will avoid sudden snapping when the band is exposed to high forces, even if there is a cut or puncture! This makes exercising with our bands much safer.

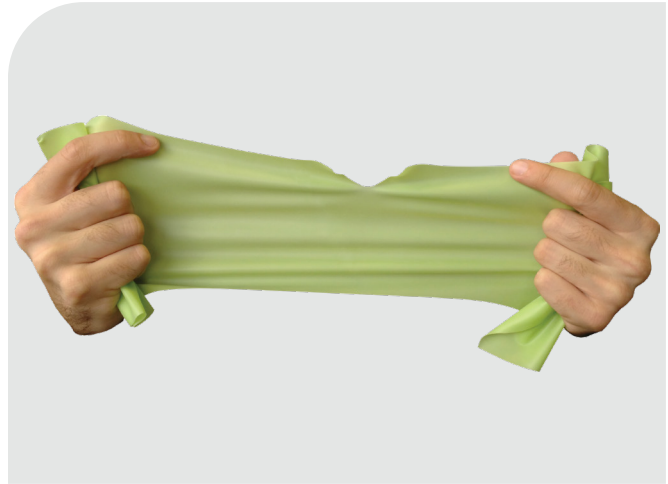

SNAP-STOP® FOR SAFER RESISTIVE EXERCISING



Elongation

Moves Bands can be stretched up to 300% elongation and Moves Loop Bands even up to 400% elongation! Therefore they are your perfect companion for a rehabilitation programme or a full body work-out. Most competitor's bands are not to be stretched more than 3 times their resting length, while a Moves Band easily achieves more, maintaining its amazing elasticity.

The high-quality material enables you to have a very wide array of resistances and possibilities.

Note:

- 50% elongation = 1,5 x lay-flat length
- 100% elongation = 2 x lay-flat length
- 150% elongation = 2,5 x lay-flat length
- 300% elongation = 4 x lay-flat length
- 400% elongation = 5 x lay-flat length

Band MD CE

Premium quality, powder-free, latex resistive exercise bands. Tear-resistant thanks to the Snap-Stop® fabrication process. The Moves Band provides positive as well as negative forces on the muscles. Furthermore it improves the range of motion, the strength and the cooperation of the muscle groups.









SPECIFICATIONS









 Lay-flat-length: available in 5 different lengths

 Width: 127mm



 Resistance: available in 8 different levels



Total Kg / Elongation %						
	50%	100%	150%	200%	250%	300%
	0,8	1,1	1,3	1,6	1,9	2,2
	0,9	1,4	1,7	2,0	2,3	2,7
	1,3	1,8	2,2	2,6	3,1	3,7
	1,6	2,3	2,8	3,3	3,9	4,6
	1,9	2,7	3,3	4,0	4,7	5,5
	2,5	3,6	4,5	5,3	6,2	7,3
	3,5	5,0	6,1	7,3	8,6	10,1
	3,8	5,4	6,7	7,9	9,4	11,0

Colour	Resistance	1.5m Dispenser 25 pcs	1.5m 10-pack	2.5m 10-pack	5.5m Box Small Roll	22.5m Box Medium Roll	45.5m Large Roll
	Tan Extra Light	n/a	n/a	n/a	01-100501	n/a	01-104501
	Yellow Light	01-100102	01-101502	01-100202	01-100502	01-102202	01-104502
	Red Medium	01-100103	01-101503	01-100203	01-100503	01-102203	01-104503
	Green Heavy	01-100104	01-101504	01-100204	01-100504	01-102204	01-104504
	Blue Extra Heavy	01-100105	01-101505	01-100205	01-100505	01-102205	01-104505
	Black Special Heavy	01-100106	01-101506	01-100206	01-100506	01-102206	01-104506
	Silver Super Heavy	n/a	01-101507	01-100207	01-100507	01-102207	n/a
	Gold Ultra Heavy	n/a	n/a	n/a	01-100508	01-102208	n/a
	Set of 5 resistances	n/a	01-101511 (5-pack)	01-100211 (5-pack)	n/a	n/a	n/a

PACKAGING

-  Dispenser 1,5m
-  Polybag: 10 individually packed pcs of the same resistance and length
-  Box with one roll: available in 3 different lengths (5,5m / 22,5m / 45,5m)

Latex-free band



Latex-Free exercise band with characteristics that are extremely close to its latex counterpart. Exceptional elasticity and 'resistance vs. elongation' linearity.

Moves Latex-Free Bands start from superior thermoplastic elastomer (TPE), so it's non-toxic and completely PVC and phthalate free.

SPECIFICATIONS

Lay-flat-length: available in 3 different lengths

Width: 100mm

Resistance: available in 5 different levels



Total Kg / Elongation %						
	50%	100%	150%	200%	250%	300%
	1,9	2,4	2,7	3,2	3,8	4,6
	2,2	2,8	3,2	3,7	4,5	5,3
	2,5	3,1	3,7	4,3	5,1	6,1
	3,2	4,1	4,8	5,6	6,6	7,9
	4,0	5,1	6,0	7,0	8,3	9,9

Colour	Resistance	1.5m 10-pack	5,5m Small roll	45,5m Large roll
	Yellow Light	O1-121502	O1-120502	O1-124502
	Red Medium	O1-121503	O1-120503	O1-124503
	Green Heavy	O1-121504	O1-120504	O1-124504
	Blue Extra Heavy	O1-121505	O1-120505	O1-124505
	Black Special Heavy	O1-121506	O1-120506	O1-124506
	Set of 5 resistances	O1-121511 (5-pack)	n/a	n/a

PACKAGING

- Polybag: 10 individually packed pcs of the same resistance and length
- Box with one small roll: 5,5m
- Box with one large roll: 45,5m

Tube MD CE

Our high-standard Moves Tubes are created by an intensive dipping process. The multiple layers guarantee a strong and safe training product. Extruded tubes are more susceptible to damage and can easily snap. So, our multi-layered dipped tubes are a superior and durable product. Train all the muscles in your body and improve your body flexibility.

Be assured of an exceptional strength to elongation linearity from our tubes.



	Total Kg / Elongation %					
	50%	100%	150%	200%	250%	300%
●	1,0	1,5	1,9	2,3	2,9	3,6
●	1,4	2,0	2,5	2,8	3,4	4,0
●	2,4	3,4	4,0	4,9	5,5	6,5
●	2,9	3,9	4,7	5,6	5,9	7,4
●	3,4	4,4	5,4	6,2	7,1	8,1
●	4,0	5,4	6,5	7,7	8,1	9,5

Colour	Resistance	120cm with handles	7,5m roll	30m roll
●	Yellow Light	01-200102	01-200702	01-203002
●	Red Medium	01-200103	01-200703	01-203003
●	Green Heavy	01-200104	01-200704	01-203004
●	Blue Extra Heavy	01-200105	01-200705	01-203005
●	Black Special Heavy	01-200106	01-200706	01-203006
●	Silver Super Heavy	01-200107	01-200707	01-203007

PACKAGING

- ✔ Polybag: 120cm tube with soft handles
- ✔ Box with 1 roll of 7,5m
- ✔ Box with roll of 30m | contains maximal 3 separate pcs - minimal length of 1 pc is 4m



COMBINE A ROLL WITH OUR SAFETY HANDLES (P.19) FOR SUPERIOR GRIP

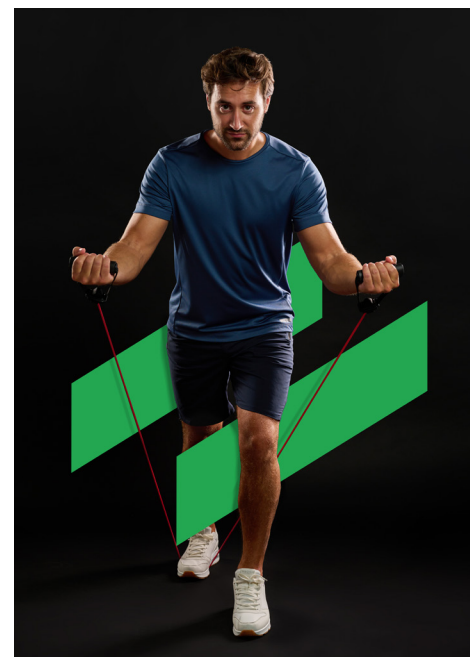



Wide loop



We offer both regular and wide loops. Wide loops are ideal for spreading forces more evenly on your body parts. They are high quality, cost effective and easy to use. The Moves Wide Loops are multi-layered and available in different resistances, thus satisfying all users.

SPECIFICATIONS

Lay-flat-length: 30cm

Width: 7,5cm

Colour	Resistance	Reference code 10-pack
	Tan Extra light	01-100071
	Yellow Light	01-100072
	Red Medium	01-100073
	Green Heavy	01-100074
	Blue Extra heavy	01-100075
	Black Special heavy	01-100076



PACKAGING

1 unit: 10 individually packed pcs of the same colour/resistance



Loop



Moves Loops are extremely portable and unbelievably versatile products. They are very effective instruments for stretching and strengthening all muscle groups. The Moves Loops are multi-layered, which makes them thicker and more durable. The benefit of these thicker loops is that they won't roll up during exercising, which avoids the uncomfortable feeling from thinner alternatives.

SPECIFICATIONS

Lay-flat-length: 30cm

Width: 2,5cm

Contains natural latex rubber

PACKAGING

Polybag: 10 individual pcs of the same colour/resistance.

Mesh bag: Set of 4 pcs of the most popular resistances

Colour	Resistance	Reference code 10-pack
	Tan Extra light	01-100001
	Yellow Light	01-100002
	Red Medium	01-100003
	Green Heavy	01-100004
	Blue Extra heavy	01-100005
	Black Special heavy	01-100006
	Set of 4 resistances	01-100011



	Total Kg / Elongation %					
	50%	100%	150%	200%	250%	300%
	1,9	2,8	3,4	4,0	4,7	5,3
	2,4	3,5	4,3	5,0	5,8	6,7
	3,1	4,5	5,6	6,6	7,6	8,7
	3,8	5,6	6,9	8,1	9,3	10,7
	4,8	7,0	8,6	10,1	11,7	13,3
	6,0	8,7	10,7	12,6	14,6	16,7

New: Fabric elastic loops set

This trendy loop set is the perfect solution for building your muscle power in an easy and effective way. Due to the anti-slip pattern, they stay exactly where they need to be and you don't have to worry about them slipping off.

- Light grey: light resistance
- Dark grey: medium resistance
- Black: heavy resistance

SPECIFICATIONS

- ✓ Comes in a mesh bag
- 👁️ Set contains 3 different resistances: light | medium | heavy

Description	Reference code	Unit
Fabric Elastic Loops	OI-704001	Set of 3



FIT band MD

Moves FIT Bands are powder-free, latex resistive exercise bands with the same premium quality as the original Moves Bands. The difference is purely the alternative, more youthful colour sequence.

SPECIFICATIONS

- Length: available in 5 different lengths
- Resistance: available in 6 different levels



Total Kg / Elongation %						
	50%	100%	150%	200%	250%	300%
	0,9	1,4	1,7	2,0	2,3	2,7
	1,3	1,8	2,2	2,6	3,1	3,7
	1,6	2,3	2,8	3,3	3,9	4,6
	1,9	2,7	3,3	4,4	4,7	5,5
	2,5	3,6	4,5	5,3	6,2	7,3
	3,5	5,0	6,1	7,3	8,6	10,1

Colour	Resistance	1,5m 10-pack	2,5m 10-pack	5,5m Small roll	22,5m Medium roll	45,5m Large roll
	Peach Light	O1-111502	O1-110202	O1-110502	n/a	O1-114502
	Orange Medium	O1-111503	O1-110203	O1-110503	n/a	O1-114503
	Lime green Heavy	O1-111504	O1-110204	O1-110504	n/a	O1-114504
	Blueberry Extra Heavy	O1-111505	O1-110205	O1-110505	n/a	O1-114505
	Plum Special Heavy	O1-111506	O1-110206	O1-110506	n/a	O1-114506
	Grey Super Heavy	O1-111507	O1-110207	O1-110507	O1-112207	n/a (5-pack)
	Set of 5 resistances	O1-111511 (5-pack)	O1-110211 (5-pack)	n/a	n/a	n/a

PACKAGING

- 5-pack: Set of 5 resistances (peach to plum) pre-cut in pieces in one pack
- 10-pack: 10 pre-cut pieces of the same resistance in one pack
- Box with one roll: available in 5,5m / 22,5m / 45,5m





FIT tube MD CE

Just like the Moves Tubes, the Moves FIT Tubes are also produced using an intensive dipping process. Therefore, these multi-layered tubes ensure a safe and strong training. This is a big advantage over extruded tubes, which are more susceptible to damage and can easily snap. Get these hip & trendy FIT colours now!

SPECIFICATIONS

 Resistance: available in 6 different levels

Total Kg / Elongation %						
	50%	100%	150%	200%	250%	300%
	1,0	1,5	1,9	2,3	2,9	3,6
	1,4	2,0	2,5	2,8	3,4	4,0
	2,4	3,4	4,0	4,9	5,5	6,5
	2,9	3,9	4,7	5,6	5,9	7,4
	3,4	4,4	5,4	6,2	7,1	8,1
	4,0	5,4	6,5	7,7	8,1	9,5

Colour	Resistance	30m roll
	Peach Light	O1-213002
	Orange Medium	O1-213003
	Lime green Heavy	O1-213004
	Blueberry Extra Heavy	O1-213005
	Plum Special Heavy	O1-213006
	Grey Super Heavy	O1-213007

PACKAGING

 Dispenser box with one roll: available in 30m







COMBINE A ROLL WITH OUR SAFETY HANDLES (P.26) FOR SUPERIOR GRIP. MOVES TUBES WITH HANDLES ARE USEFUL FOR PHYSIOTHERAPY AND MUSCLE TRAINING.

FIT loop MD CE



Our excellent and durable loops are also available in Moves FIT colours. The Moves FIT Loops are easy to use and very versatile. You can stretch and strengthen all muscle groups.

These Loops are multi-layered which makes them thicker and more durable.

SPECIFICATIONS

-  Lay-flat-length: 30cm
-  Width: 2,5cm
-  Resistance: available in 4 levels
-  Contains natural latex rubber

PACKAGING

-  Polybag: 10 individual pcs of the same colour/resistance
-  Mesh bag: Set of 4 pcs of the most popular resistances





Colour	Resistance	Reference code 10-pack
	Peach Light	01-110002
	Orange Medium	01-110003
	Lime green Heavy	01-110004
	Blueberry Extra heavy	01-110005
	Set of 4 resistances	01-110011

FIT superloop MD CE





With the Moves FIT Superloop you can easily stretch and strengthen different muscle groups. It can be used for rehabilitation, fitness and strength training.

The Moves FIT Superloop is also multi-layered, which makes it a very durable product. Because of its long lay-flat length and circumference, the FIT Superloop allows you to stretch and strengthen several muscle groups at the same time.

SPECIFICATIONS

-  Lay-flat length: 104cm
-  Circumference: 208cm
-  Resistance: available in 5 different levels



Colour	Resistance	Reference code 1 pc
	Peach Light	01-110402
	Orange Medium	01-110403
	Lime green Heavy	01-110404
	Blueberry Extra heavy	01-110405
	Plum Special heavy	01-110406

		Total Kg / Elongation %					
Width x Thickness in mm		50%	100%	150%	200%	250%	300%
	15 x 3,0	4,3	6,0	7,2	8,4	9,7	11,1
	22 x 4,0	8,5	11,8	14,1	16,5	19,0	21,7
	30 x 4,4	12,7	17,6	21,2	24,7	28,5	32,5
	40 x 4,4	16,9	23,5	28,3	32,9	38,0	43,4
	53 x 4,4	22,4	31,2	37,4	43,6	50,3	57,5



Bar MD €

Golfer's or tennis elbow? The Moves Bar is the ideal product to treat and resolve this!

This effective product is developed to focus on hand, arm and shoulder problems. This product allows flexion and tension exercises, adduction and abduction exercises and even soft tissue mobilisation. So, far more possibilities than only twisting and bending!



SPECIFICATIONS

- Length: 31cm
- Width: 4,5cm
- Material: dried natural rubber

PACKAGING

- Polybag: containing 1 pc

Colour	Resistance	Kg-Force*	Reference code	Unit
	Extra light	1,8	OI-600101	1 pc
	Light	3,0	OI-600102	1 pc
	Medium	5,0	OI-600103	1 pc
	Heavy	7,0	OI-600104	1 pc
	Extra heavy	11,0	OI-600105	1 pc
	Special heavy	14,0	OI-600106	1 pc

*FORCE APPLIED WHEN BENDING THE BAR TO A U-SHAPE



Ring tube MD €

The **Moves Cuff-ring Tube** is a versatile exercise tool to tone and strengthen all the muscles of the lower body. With velcro closure that can be adjusted to all sizes.

The **Moves 8-Ring Tube** offers lots of possibilities for short and long pull exercises thanks to its centre. Used for intensive training of isolated muscles. Efficient for all muscles of the upper- and lower body.

With the **Moves O-Ring Tube** you get an intensive training of each muscular group. Ideal for abdomen, bottom, hip and leg exercises.



MOVES CUFF-RING TUBE

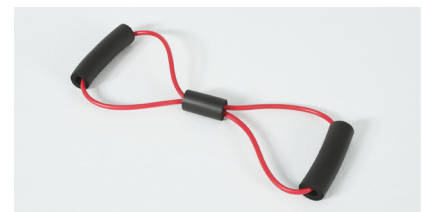

MOVES 8-RING TUBE

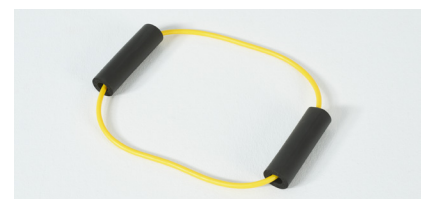

MOVES O-RING TUBE

Colour	Resistance	Reference code			Unit
		Cuff-Ring Tube Loop	Figure 8-Ring Loop	O-Ring Tube Loop	
	Yellow Light	OI-200402	OI-200302	OI-200202	1 pc
	Red Medium	OI-200403	OI-200303	OI-200203	1 pc
	Green Heavy	OI-200404	OI-200304	OI-200204	1 pc
	Blue Extra heavy	OI-200405	OI-200305	OI-200205	1 pc
	Black Special heavy	OI-200406	OI-200306	OI-200206	1 pc





moves



Ankleciser

The Moves Ankleciser is the ideal product to exercise your ankles. It's as easy in use as it is effective. The feet slip comfortably into the band which consists of two stitched loops. This progressive exercise system enables the user to choose the desired resistance level to perform the exercises.





SPECIFICATIONS

-  Length: 31cm
-  Resistance: available in 4 different levels
-  Material: latex-free elastic band

PACKAGING

-  Polybag: 5 pcs of the same colour/resistance
-  Set of 4 different colours/resistances



Colour	Resistance	Reference code	Unit
	Yellow Light	01-500102	5 pcs
	Red Medium	01-500103	5 pcs
	Green Heavy	01-500104	5 pcs
	Blue Extra heavy	01-500105	5 pcs
	Set of 4 resistances	01-500111	4 pcs

Shoulder rope pulley

The Moves Shoulder Rope Pulley is an economical, easy-to-use device that helps increase range of shoulder motion. It can be used for prevention and rehabilitation of shoulder injuries.

1. DOOR ANCHOR | NOTCH HANDLES

MD CE

This product comes with a pulley, door anchor, nylon cord, stopper system and notch handles. The unique notch handles allow the user to easily adjust the length of the rope through the handle while the revolutionary stopper system is a great aid for consistent and progressive exercising.

Reference code	Unit
01-400101	1 pc

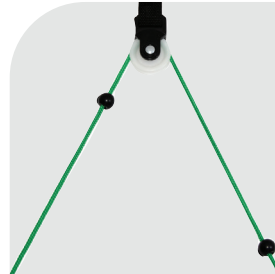

DOOR ANCHOR, NYLON CORD AND STOPPER SYSTEM



NOTCH HANDLE

2. DOOR ANCHOR | WOODEN HANDLES

MD CE

This version of the Moves Shoulder rope pulley comes with a pulley, door anchor, nylon cord, stopper system and wooden handles.

Reference code	Unit
01-400105	1 pc

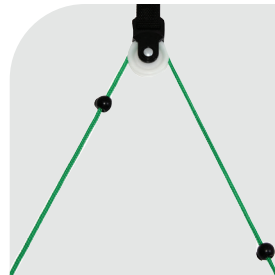

DOOR ANCHOR, NYLON CORD AND STOPPER SYSTEM



WOODEN HANDLE

3. DOOR ANCHOR | HAND SUPPORT

MD CE

This product comes with a pulley, door anchor, nylon cord, stopper system and detachable hand support. This hand support allows patients without gripping power to use the shoulder pulley.

Reference code	Unit
01-400103	1 pc

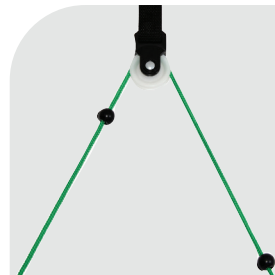

DOOR ANCHOR, NYLON CORD AND STOPPER SYSTEM

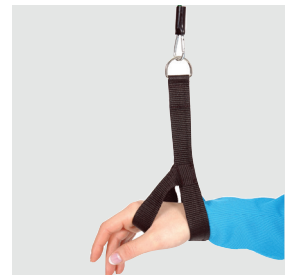

HAND SUPPORT

4. METAL BRACKET

MD CE

This product comes with a pulley, door anchor, nylon cord, stopper system and metal bracket. This allows you to easily mount the shoulder rope pulley in a doorway.

Reference code	Unit
01-400102	1 pc



METAL BRACKET

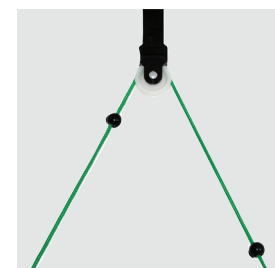

DOOR ANCHOR, NYLON CORD AND STOPPER SYSTEM



WOODEN HANDLE

5. VALUE PACK

The Moves shoulder rope pulley VALUE PACK comes in a polybag, with notch handles but **without stoppers** on the nylon cord.

Reference code	Unit
01-400104	1 pc

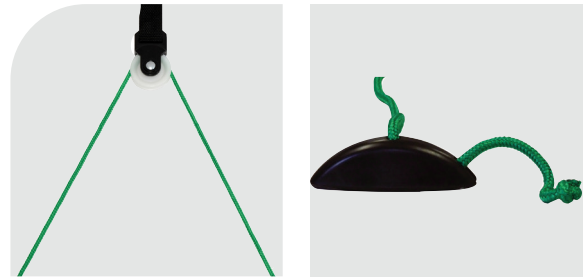

DOOR ANCHOR AND NYLON CORD

NOTCH HANDLE

moves

Shoulder tube pulley MD CE

Just like the Moves Shoulder Rope Pulley, the Moves Shoulder Tube Pulley helps increase range of shoulder motion. It can be used for prevention and rehabilitation of shoulder injuries.

SPECIFICATIONS

 Resistance: available in 3 different levels

PACKAGING

 Pack: containing 1 tube of the selected colour/ resistance, soft handles, pulley and door anchor



Colour	Resistance	Reference code	Unit
	Yellow Light	01-400202	1 pc
	Red Medium	01-400203	1 pc
	Green Heavy	01-400204	1 pc

moves

Knee rope pulley MD CE

The Moves Knee Rope Pulley helps increase range of knee motion. This easy-to-use product can be mounted in a doorway to help you recover from or prevent knee injuries.

While sitting on a chair, put your foot into the ankle strap. A rope starts from the ankle strap, goes through a pulley and ends at a wooden handle designed for a 2-handed grip. Pull your foot carefully upwards by moving the handle towards your abdomen which will generate a rotational movement at your knee.

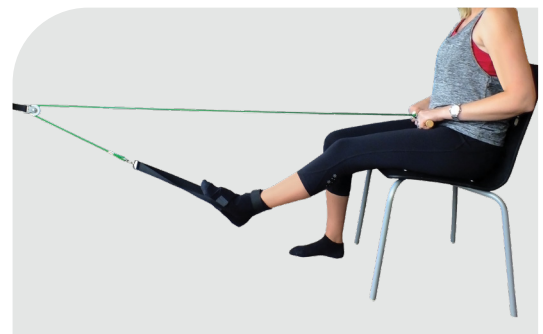

Reference code	Description	Unit
01-400301	Moves Knee Rope Pulley Door anchor 2-handed Wooded handle Ankle strap	1 pc

Accessories



SAFETY HANDLES



SOFT HANDLES



DOOR ANCHOR



MOVES BAND & TUBING SCISSORS

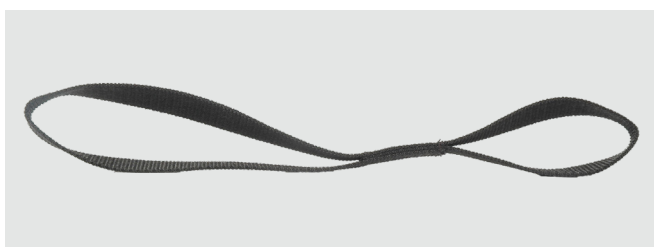

UNIVERSAL ASSIST

Reference code	Description	Unit
01-300101	Moves Safety Handles	pair
01-300102	Moves Soft Handles	pair
01-300103	Moves Door Anchor	1 pc
01-300104	Moves Universal Assist	1 pc
01-300106	Moves Band & Tubing scissors	1 pc

O2 Hand





Flex-Ion MD CE

The Moves Flex-Ion is the ultimate rehabilitation product after a hand injury. The spring-loaded buttons isolate each digit so stronger fingers cannot compensate for the weaker ones. This results in a better, faster & more controllable rehab process.

The gradual resistance system of the Moves Flex-Ion helps therapists measure progress. Additionally, the ergonomic base adds comfort and stability.

The Moves brand assures a top-notch product!

SPECIFICATIONS

- Resistance: available in 6 different levels
- Material: display in metal

Colour	Resistance: 1 digit / all digits	Reference code	Unit
	Tan 0,35 kg / 1,1 kg	O2-000101	1 pc
	Yellow 0,7 kg / 2,3 kg	O2-000102	1 pc
	Red 1,4 kg / 4,5 kg	O2-000103	1 pc
	Green 2,3 kg / 7,3 kg	O2-000104	1 pc
	Blue 3,2 kg / 10,4 kg	O2-000105	1 pc
	Black 4,1 kg / 14,1 kg	O2-000106	1 pc
	Set of 6 resistances in 1 display	O2-000111	set of 6 pcs
	Empty display	O2-000121	1 pc

PACKAGING

- One Flex-Ion of the selected colour/ resistance
- Set of 6 different colours/resistances (with display)



UNIVERSAL ASSIST



SET WITH DISPLAY

Digi-Flex® MD CE

Digi-Flex® develops isolated finger strength, flexibility and coordination. It is suitable for rehabilitation after hand injury.



PACKAGING

- ✓ One Digi-Flex® of the selected colour / resistance
- ✓ Set of 5 different colours/resistances (with display)

Colour	Resistance: 1 digit / all digits	Reference code	Unit
●	Yellow 0,7 kg / 2,3 kg	O2-O1O1O2	1 pc
●	Red 1,4 kg / 4,5 kg	O2-O1O1O3	1 pc
●	Green 2,3 kg / 7,3 kg	O2-O1O1O4	1 pc
●	Blue 3,2 kg / 10,4 kg	O2-O1O1O5	1 pc
●	Black 4,1 kg / 14,1 kg	O2-O1O1O6	1 pc
● ● ● ● ●	Set of 5 resistances in 1 display	O2-O1O1I1	Set of 5 pcs
	Empty display	O2-O1O121	1 pc

Digi-Extend® MD CE

The Digi-Extend® is a unique therapy device that can isolate the extension of all five fingers and each of the individual finger joints. The product strengthens the intrinsic and extrinsic muscle groups to maximise extensor tendon gliding, joint motion, coordination and muscle function in the hand and forearm.

Patients can choose between 5 resistance levels that are easily changeable. This way, you can vary the hand positions for specific exercises to help maximise your exercise goals and prevent injury.

Reference	Description	Unit
O2-O1O2O1	Digi-Extend Bands (tan to green) included	1 pc
O2-O1O2I1	Digi-Extend Set 4 units 1 Display	set
O2-O1O2O2	Digi-Extend Band Set 25 pc 5x ● 5x ● 5x ● 5x ● 5x ●	set
O2-O1O221	Digi-Extend Empty Display (metal)	1 pc

Bands included:

- 5x ●
- 4x ●
- 3x ●
- 2x ●



Handmaster Plus™

9 muscles close the hand, 9 muscles open the hand and 9 muscles control the position of the hand. The HandMaster Plus™ trains and balances all of these 27 muscles. Therefore, it is the ideal finger, thumb, hand and wrist exerciser!



SOFT | FOR LIGHT EXERCISE
PURPLE BALL - YELLOW CORD

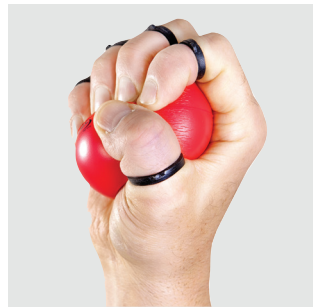

MEDIUM | FOR MEDIUM EXERCISE
RED BALL - BLACK CORD



FIRM | FOR STRENGTH, SPEED TRAINING
ORANGE BALL - GREY CORD

Reference	Description	Colour	Unit
O2-O5O1O2	Handmaster Plus Purple ball - Yellow Cord		1 pc
O2-O5O1O3	Handmaster Plus Medium Red ball - Black cord		1 pc
O2-O5O1O4	Handmaster Plus Firm Orange ball - Grey cord		1 pc
O2-O5O1I1	Handmaster Plus Set of 3 (one of each level)		Set

3-pack set
=
3 balls for the price of 2!

Prohands® series

VIA™ is an entry level hand exerciser designed with young athletes in mind. It has a round, soft look and wide finger pistons for smoother function & improved finger performance.

Colour	Resistance (per digit)	Reference code	Unit
	Light 1,5 kg	O2-O6O1O2	1 pc
	Medium 2,5 kg	O2-O6O1O3	1 pc



SPECIFICATIONS

Resistance: available in 2 different levels

PRO™ provides serious athletes with the most advanced hand exerciser in the world. The PRO™ features a larger profile, superior steel springs and an integrated ergonomic palm bar for comfort.

Colour	Resistance (per digit)	Reference code	Unit
	Medium 3,5 kg	O2-O6O3O3	1 pc
	Heavy 4,5 kg	O2-O6O3O4	1 pc
	Extra heavy 5,5 kg	O2-O6O3O5	1 pc



SPECIFICATIONS

Resistance: available in 3 different levels

VariGrip Therapy

This product has the ability to **adjust tension in each individual finger**. The resistance from each single finger knob can easily be adjusted incrementally on the patient's need, which minimises overcompensation and strain. This also allows the patient to progress steadily.

Comparison Chart (kg per digit)

VariGrip	X-Light	Light	Medium	Heavy	X-Heavy
Digi-Flex® / Flex-Ion	0,7	1,4	2,3	3,2	4,1

Each VariGrip's highest resistance ends where the next VariGrip resistance starts. Any other hand exerciser increases from light (1,4 kg) to medium (2,3 kg). That's almost a 70% increase gap, which can cause an overload on the muscles, resulting in injuries. The seamless progress from one VariGrip to the other, supported by the **padded finger and palm area**, guarantees a safe recovery and better feel for those with sensitivity issues.

Reference code	Colour	Resistance (range per digit) and level	Unit
O2-100102	Yellow	X-Light 0,7 - 1,4 kg Level 1	1 pc
O2-100106	Black	X-Heavy 4,1 - 5,4 kg Level 5	1 pc
O2-100107		VariGrip set 5 resistances 1 display	Set of 5
O2-100108		VariGrip empty display Plastic	1 pc



VariGrip Sport

The VariGrip Sport has the patented ability to **adjust the tension level in each individual finger**. This allows the user to create a custom programme to build and improve endurance, strength and dexterity more effectively for individual fingers, as well as the entire hand, wrist and forearm.

The VariGrip Sport is the only exerciser of its kind that includes a **callus builder**, ideal for climbers, gymnasts, gamers, musicians, and athletes of all levels.

This product also has **soft touch digits**, which provide comfort for users with sensitivity issues.

Reference code	Description	Resistance (kg)	Unit
O2-100303	VariGrip Sport	2,3 - 4,1 kg	1 pc



Constant Force X-Tend

Unlike elastic-based exercisers that increase in resistance the further the unit is extended, this product uses retractable-based resistance, which keeps a constant level of resistance from start to finish. Ergonomic in design, the Constant Force X-Tend works the intrinsic and extrinsic extensors of the hand and can isolate MP/PIP/DIP joint motion.

Reference code	Colour	Resistance (per digit)	Unit
O2-100403	Red	Light 0,11 kg	1 pc
O2-100405	Blue	Heavy 0,27 kg	1 pc



POWER-WEB

Power-Web® Combo MD CE

The Power-Web® Combo features a unique advantage of two resistance levels in one, offering greater flexibility and value.

The #1 hand exercise web in the world!

Each Power-Web® comes with a 39 exercise poster!

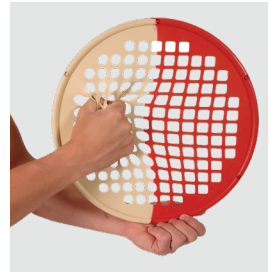
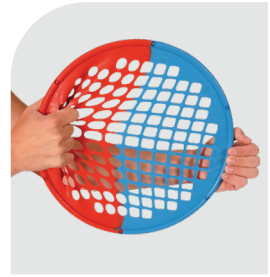

SPECIFICATIONS

36 cm

450 gr

Reference code	Colour	Resistance	Unit
O2-O2O1O1		Tan - Red Ultra light - Medium	1 pc
O2-O2O1O2		Yellow - Green Light - Heavy	1 pc
O2-O2O1O3		Red - Blue Medium - Super heavy	1 pc
O2-O2O1O4		Green - Black Heavy - Ultra heavy	1 pc

POWER-WEB

Power-Web® Senior MD CE

The unique patented design allows a variety of exercises to be performed comfortably and effectively. Constructed of the finest rubber with special agents added for durability and strength, the Power-Web® will last for years.

SPECIFICATIONS

36 cm

450 gr

Reference code	Colour	Resistance	Unit
O2-O2O2O1		Tan Ultra light	1 pc
O2-O2O2O2		Yellow Light	1 pc
O2-O2O2O3		Red Medium	1 pc
O2-O2O2O4		Green Heavy	1 pc
O2-O2O2O5		Blue Super heavy	1 pc
O2-O2O2O6		Black Ultra heavy	1 pc



POWER-WEB

Power-Web® Junior MD CE

Just half the size of the Power-Web® Senior, this product has all the same features as its larger counterpart.

SPECIFICATIONS

18 cm

225 gr

Reference code	Colour	Resistance	Unit
O2-O2O3O2		Yellow Light	1 pc
O2-O2O3O3		Red Medium	1 pc
O2-O2O3O4		Green Heavy	1 pc



Power-Web® Flex-Grip MD CE

A distinctive and accessible exerciser that fits in the palm of your hand and provides the ability to work dexterity, extension and strengthening in your hands, fingers and thumbs. The Power-Web® Flex-Grip® has finger and thumb holes and has two sides: one side featuring a ball to squeeze and the other side featuring buttons and a thumb pad to exercise fingers separately.



SPECIFICATIONS

 Resistance: available in 3 different levels

 Material: Latex-free

Colour	Resistance	Reference code	Unit
●	Yellow Light	O2-O21102	1 pc
●	Red Medium	O2-O21103	1 pc
●	Green Heavy	O2-O21104	1 pc



Adjustable hand grip

Train your hand strength with the Mambo Max Adjustable Hand Grip. This product comes in two different versions. A light (orange) version and a heavy (grey) version. Both can be adjusted to the tension you desire by turning the control knob.



LIGHT VERSION



HEAVY VERSION

Description	Resistance	Reference code	Unit
Mambo Max Adjustable Hand Grip Light	5 to 20 kg 11 to 44 lb	O2-O70102	1 pc
Mambo Max Adjustable Hand Grip Heavy	10 to 40 kg 22 to 88 lb	O2-O70104	1 pc



Foam hand grip

Due to its foam handles, the Mambo Max Foam Hand Grip provides a firm grip for the entire workout session.



Description	Gripping power	Reference code	Unit
Mambo Max Foam Hand Grip	20 kg 44 lb	O2-O80101	Pair

Squeeze balls & eggs



The Moves Squeeze Ball provides a progressive sequence of 5 colours/resistances. It strengthens hands, fingers, forearms and will work the muscles separately or in tandem. It's a small and accessible product that you can bring anywhere.

The Moves Squeeze Egg, also available in 5 levels, is ergonomically shaped to provide highly effective exercise for the rehabilitation and strengthening of weakened or injured fingers, hands and wrists.

Both the Balls and Eggs are compact and easy to use products that you can take everywhere you go. They can help to:

- ✔ Rehabilitate post-operative / post-traumatic hands and arms
- ✔ Restore function in hands, arms and shoulders following a stroke
- ✔ Reduce Pain and stiffness in arthritic fingers, hands and wrists
- ✔ Relax tense, sore muscles
- ✔ Reduce stress
- ✔ Strengthen ageing hands and arms

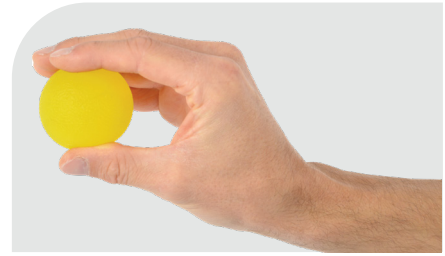

Colour	Resistance	Reference code - Ball	Reference code - Egg	Unit
● Yellow	Yellow Extra soft	O2-O3O1O2	O2-O3O2O2	1 pc
● Red	Red Soft	O2-O3O1O3	O2-O3O2O3	1 pc
● Green	Green Medium	O2-O3O1O4	O2-O3O2O4	1 pc
● Blue	Blue Firm	O2-O3O1O5	O2-O3O2O5	1 pc
● Black	Black Extra firm	O2-O3O1O6	O2-O3O2O6	1 pc

PACKAGING

- ✔ 1 individually packed pc of the Moves Squeeze Ball or Egg

Wrist exerciser

The Moves Wrist Exerciser is an adjustable wrist and forearm trainer which allows the user to exercise with progressive resistance. Its ergonomically designed forearm support keeps the wrist in the right place. Together with the soft handgrip, adjustable to 4 positions, it ensures maximum comfort while exercising your wrist and forearm.



Description	Reference code	Unit
Moves Wrist Exerciser	O2-O7O2O1	1 pc

Comfort putty



The Moves Comfort Putty strengthens weakened grasp through exercise and is used for rehabilitation or stress relief.

It is odourless, does not stain and will not leave any residue on the patient's hands. Moreover, the Moves Comfort Putty is non-toxic, greaseless, hypo-allergenic and it contains **antimicrobial agents**.

Be assured of a top-tier product due to the Moves label!



SPECIFICATIONS

- Resistance: available in 6 different levels
- Material: Latex-free, Gluten-free, contains anti-microbial agents
- Available in 2 weights: 85 g and 454 g

Colour	Resistance	Reference code		Unit
		85 g	454 g	
	White Special Soft	O2-090101	O2-090401	1 pc
	Tan Extra soft	O2-090102	O2-090402	1 pc
	Yellow Soft	O2-090103	O2-090403	1 pc
	Red Medium	O2-090104	O2-090404	1 pc
	Green Firm	O2-090105	O2-090405	1 pc
	Blue Extra firm	O2-090106	O2-090406	1 pc



PACKAGING

- 1 putty of the selected colour/resistance pre-packed in a container of the chosen weight

Why antimicrobial agents?

Antimicrobial agents **kill bacteria** without additives and they **prevent the growth of odour-causing microbes**. Moves Comfort Putty contains natural anti-microbial agents without the addition of toxic chemicals. This ensures that the Moves Comfort Putty material **retains its hygienic, non-greasy feel** from day one. Cheaper alternatives on the market do not contain these agents, which makes them the ideal breeding ground for bacteria and fungi. Why? Because a small number of bacteria and other micro-organisms will always be present on the patient's hands and because putty should be stored in room temperature conditions. This makes antimicrobial agents **a must for this product**. Apart from protecting the putty from bacteria and fungi, antimicrobial agents also **extend the product's lifespan** and **improve its cleanliness**.

Benefits of antimicrobial agents:

- Non-greasy
- Hygienic
- Clean
- Durability
- Odourless
- Allows multiple users



Theraflex™ putty



Just like the Moves Comfort Putty, the Theraflex™ Putty is multi-purposed: it can be used for both rehabilitation purposes, as for stress relief. It is odourless, does not stain and will not leave any residue on the patient's hand. Theraflex™ Putty is also non-toxic, greaseless, hypo-allergenic and it contains **antimicrobial agents** which makes it a very hygienic & safe product to use.



SPECIFICATIONS

- Resistance: available in 6 different levels
- Material: Latex-free, Gluten-free, contains anti-microbial agents
- Available in 6 different weights: 57 g - 85 g - 113 g - 170 g - 454 g - 2,3 kg

Colour	Resistance	Reference code	Reference code	Reference code	Reference code	Reference code	Reference code
		57 g - 1 pc	85 g - 1 pc	113 g - 1 pc	170 g - 1 pc	454 g - 1 pc	2,3 kg - 1 pc
○	White Special Soft	n/a	O2-O40100	n/a	n/a	O2-O40400	n/a
●	Tan Extra soft	O2-O40001	O2-O40101	O2-O40201	O2-O40301	O2-O40401	O2-O40501
●	Yellow Soft	O2-O40002	O2-O40102	O2-O40202	O2-O40302	O2-O40402	O2-O40502
●	Red Medium	O2-O40003	O2-O40103	O2-O40203	O2-O40303	O2-O40403	O2-O40503
●	Green Firm	O2-O40004	O2-O40104	O2-O40204	O2-O40304	O2-O40404	O2-O40504
●	Blue Extra firm	O2-O40005	O2-O40105	O2-O40205	O2-O40305	O2-O40405	O2-O40505

PACKAGING

- 1 Putty of the selected colour/resistance pre-packed in a container of the chosen weight.



WEIGHTS: 2,3 KG | 454 G | 170 G | 113 G | 85 G | 57 G

Therapie Sand



Therapie Sand is an innovative material that provides a soothing tactile-kinesthetic experience and is equally popular among both children and adults. The sand promotes fine motor skills and sensitivity, stimulates circulation to relieve everyday stress, and restores mobility and overall strengthening of the wrists and ankles.

This product is primarily used in therapy to promote sensitivity and optimize the mobility of finger, hand, feet, toe, and ankle joints. It improves overall strength and hand-foot coordination. Additionally, the Therapie Sand is an excellent educational aid, particularly in the fields of occupational therapy and physiotherapy, for the purpose of stimulating creativity and development.

With the Therapie Sand you can train, play and destress all at once.

SPECIFICATIONS

- Material: Latex-free sand
- Available in 2 different weights: 454 g - 2 kg

Colour	Reference code	Description	Unit
●	O2-240401	Therapie Sand 454 g Grey	1 pc
	O2-240501	Therapie Sand 2 kg Grey	1 pc



O3 Upper & lower body





Oxycycle 1 - active magnetic



For ACTIVE training only | For HOME use only

The Moves Oxycycle 1 Pedal Exerciser is used for upper and lower body exercises. This is a great product to progressively strengthen your arms and legs, because you can **adjust the resistance**.

SPECIFICATIONS

- ↔ Measurements: 50 x 46 x 38 cm
- 🛒 Weight: 9 kg
- 📄 Multi-function LCD display readout of scan, time, distance, calories and RPM
- ✔ Including: non-skid mat, interchangeable handgrip pedals and velcro strap pedals
- 🕒 **Maximum 1 hour per day**
Maximum 30 minutes per session

Reference code	Description	Unit
O3-O1O1O1	Moves Oxycycle 1 Pedal Exerciser	1 pc



Oxycycle 2 - passive



For PASSIVE training only | For HOME use only

The Moves Oxycycle 2 Pedal Exerciser is a great tool for personalised, low-stress workouts at home. The **adjustable speed level** makes it the ideal product to gradually strengthen your arms and legs. This pedal exerciser provides low-impact exercise to increase strength and flexibility. It's versatile for both upper and lower body and it improves the blood circulation.

It offers up to 60 Watts of motorized assistance, whereas cheaper models only carry a 30-Watt motor. So the Oxycycle 2 has enough power to maintain a constant rotational speed. A safety stop will avoid injury in case of cramp or muscle spasm.

SPECIFICATIONS

- ↔ Measurements: 50 x 46 x 38 cm
- 🛒 Weight: 8,5 kg
- 📄 Multi-function LCD display readout of scan, time, count, RPM-level and estimated calories burned
Hz: 50
RPM: 25 - 65 (Rotations Per Minute)
- ✔ Including: non-skid mat, interchangeable handgrip pedals and half-foot pedals
- 🔌 This product comes with a UK or EU plug
- 🕒 **Maximum 1 hour per day**
Maximum 30 minutes per session

Reference code	Description	Unit
O3-O1O1O2	Moves Oxycycle 2 Pedal Exerciser EU-plug	1 pc
O3-O1O1O2 UK	Moves Oxycycle 2 Pedal Exerciser UK-plug	1 pc

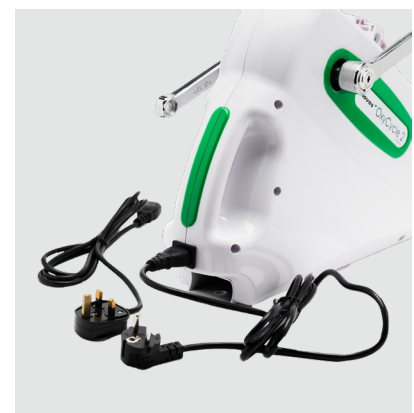

Oxycycle 3+ active & passive CE

For ACTIVE and PASSIVE training | For HOME use only

The Oxycycle 3+ provides the same exercise as the Oxycycle 3, but with a **redesigned controller and improved parts!** So, increase your strength and flexibility with the upgraded Moves Oxycycle 3+. This low-impact pedal exerciser can **adjust both the speed level and resistance**, which makes it the ultimate product to build strength in your arms and legs.

The Moves Oxycycle 3+ offers up to 80 Watts of motorized assistance. This assures a constant rotational speed. For your safety, a stop is integrated to prevent injury in case of a cramp or muscle spasm.



SPECIFICATIONS

- ↔ Measurements: 50 x 46 x 38 cm
- 📏 Weight: 8,5 kg
- 📄 Multi-function LCD display readout of scan, time, count, RPM-level and estimated calories burned
- 📄 **Hz: 50**
RPM: 25 - 65 (Rotations Per Minute)
- ✔ Including: non-skid mat, interchangeable handgrip pedals and full-foot pedals
- 🔌 This product comes with a UK or EU plug
- 🕒 **Maximum 1 hour per day**
Maximum 30 minutes per session

Reference code	Description	Unit
O3-O1O1O4	Moves Oxycycle 3+ Pedal Exerciser EU-plug	1 pc
O3-O1O1O4 UK	Moves Oxycycle 3+ Pedal Exerciser UK-plug	1 pc

Oxycycle pedals

All Moves Oxycycle Pedals are interchangeable and fit the Oxycycle 1, 2 and 3!

Reference code	Description	Unit
O3-O2O1O1	Moves Velcro Strap Pedals	pair
O3-O2O1O2	Moves Half-Foot Pedals	pair
O3-O2O1O3	Moves Full-Foot Pedals	pair
O3-O2O2O1	Moves Handgrip Pedals	pair



VELCRO STRAP PEDALS



HALF-FOOT PEDALS



FULL-FOOT PEDALS



HANDGRIP PEDALS

CuraMotion

The CuraMotion is used for the improvement of muscle strength and joint range of motion. The CuraMotion Exer Series has an adjustable resistance and a multi-functional LCD-display readout scan which indicates a lot of interesting metrics. All products are easily adjustable with a quick release knob.

SPECIFICATIONS

 Multi-functional LCD-display readout of scan, rotation count, rotations per minute, time exercised and calories burned.

Reference code	Description	Unit
O3-O3O1O1	CuraMotion Exer 1	1 pc
O3-O3O1O2	CuraMotion Exer 2	1 pc
O3-O3O1O3	CuraMotion Exer 3	1 pc
O3-O3O1O4	CuraMotion Exer 4	1 pc

EXER 1

 Measurements: 96 x 45 x 45 cm

 Weight: 11,5 kg

 Wall mount included



EXER 2

 Measurements: 146 x 45 x 54 cm

 Weight: 13,5 kg

 Wall mount included

 Adjustable height





EXER 3

 Measurements: 37 x 38 x 70 cm

 Weight: 9 kg

 With foot stands

EXER 4

 Measurements: 96 x 45 x 45 cm

 Weight: 13 kg

 Wall mount included





Foldable pedal exerciser MD €

The Moves Pedal Exercisers are optimal for restoring impaired muscle strength, improving blood circulation and a better coordination for the legs and arms. It can be used on a table top as an arm exerciser or on the floor for a leg workout. A convenient resistance control knob allows a broad range of pedal resistance for a progressive exercise programme. This Moves Pedal Exerciser is foldable for compact shipping and storage. This product also provides an easy setup.

SPECIFICATIONS

- ↔ Measurements: 49 x 36 x 27 cm
- 📏 Weight: 2,3 kg
- 📄 Multi-function LCD display readout of scan, time, RPM, total rotations and calories
- ✔ Including: pedal straps that are adjustable to 2 positions

Reference code	Description	Unit
O3-O1O2O3	Moves Foldable Pedal Exerciser + LCD Display	1 pc



Standard pedal exerciser | premium chrome MD €

This Moves Pedal Exerciser is pre-assembled. The product has a high standard chrome finish and comes in a colour box.

SPECIFICATIONS

- ↔ Measurements: 52 x 42 x 26 cm
- 📏 Weight: 2 kg
- ✔ Option to buy 1 pc or 6 pcs in bulk
- ✔ Including: pedal straps that are adjustable to 2 positions

Reference code	Description	Unit
O3-O1O2O1	Moves Standard Pedal Exerciser Premium Chrome	1 pc



Standard pedal exerciser K/D MD €

Are you looking for a budget solution to stay active after an injury? Or do you want a product to improve your coordination and the blood circulation of the upper and lower body? Then the Knock-down Moves Pedal Exerciser is perfect for you. It only takes 6 screws to (dis)assemble this product, so this product is ideal for compact shipping and storage.

SPECIFICATIONS

- ↔ Measurements: 51 x 41 x 28 cm
- 📏 Weight: 2 kg
- ✔ Including: pedal straps that are adjustable to 2 positions

Reference code	Description	Unit
O3-O1O2O2	Moves Standard Pedal Exerciser K/D White	1 pc



New: Moves cycle









The Moves Cycle pedal exerciser helps **prevent, reduce, and improve the effects of immobility**. It is mainly used for conditions such as neuromuscular, orthopedic, cardiovascular, and metabolic disorders, as well as other medical conditions that limit movement or cause bed confinement.

Thanks to its durable and high-grade design, this active-passive exerciser can operate for several hours! This product is perfect for **professionals** as the focus is on continuous and long-term use.

The Moves Cycle offers several unique features. For instance, when used in passive or preset modes, the **pedals can rotate both forward and backward**. Additionally, this pedal exerciser has a convenient **quick-release system** for changing pedals. By simply pressing the pre-installed adaptors on the cranks, you can easily insert or remove your preferred pedals.

SPECIFICATIONS

-  Input power is 100v ~ 240v
-  5 exercise modes: active, passive, 3 preset modes with different intensities
-  Has anti-spasm detection
-  Including: adaptor, console with display, safety key, mat, AC cord
-  Comes with big foot pedals for leg exercises, and hand grips for arm exercises

 **Professional use!**
Designed for continuous, long-term use

Reference code	Description	Unit
O3-070101	Moves Cycle (active & passive trainer)	1 pc





New: ElliptiStep CE

The Mambo Max ElliptiStep is an electromagnetic elliptical trainer. This compact and portable device is used for low-impact cardio-vascular exercise while sitting. The ElliptiStep enhances your lower body strength and flexibility while tackling sedentary behavior. Specifically targeting users at home or at work.

The ElliptiStep has an **active mode** and an **auto mode** (with motorized assistance). The display panel shows values such as speed (in active mode), resistance (in auto mode), distance, calories, and time. While exercising in auto mode, you can also put the elliptical trainer in reverse.

SPECIFICATIONS

- ↔ Measurements: 42 x 41 x 28 cm
- 🛒 Weight: 7,08 kg
- 📄 HD panel shows: speed, resistance, distance, calories burned, and time
- ✔ Including power cord and controller with button cell battery

Reference code	Description	Unit
03-070150	Mambo Max ElliptiStep	1 pc



Fit stretch MD CE

The Fit Stretch is a fantastic, simple and portable tool to stretch your lower leg muscles. It is the ultimate product for warm-ups and cool-downs. The use of a Mambo Max Fit Stretch helps increase your ankle, shin and calf flexibility.

SPECIFICATIONS

- 🔍 Material: made of durable moulded plastic
- ✔ Including non-skid foot pad

Reference code	Description	Unit
03-050101	Mambo Max Fit Stretch Single Leg	1 pc



Wooden incline board MD CE

The Incline Board increases extension in the lower and upper back while stretching the calves. It can be used to:

- improve the general posture,
- stretch the calf muscles of athletes, football players and sportspersons in general,
- stretch the upper-leg muscles (Ischias),
- increase extension in the lower and upper back.

THE MOVES WOODEN INCLINE BOARD - FIX

The perfect product if you are looking for an easy and budget-friendly Incline Board. It's made out of polymerised wood for a strong feel and high user weight. The inclination (17,5°) is perfect for physiotherapy exercises.



↔ Measurements: 45 x 30 x 16 cm

Reference code	Description	Unit
03-040003	Moves Wooden Incline Board - Fix	1 pc



Adjustable wooden incline board

The Mambo Max adjustable wooden incline board completes your workout setup. It is crafted from durable poplar wood and has a multi-layered board. This board can be adjusted in 4 different angles and conveniently folds for easy storage. Its slip-resistant stepping surface ensures stability during workouts. Experience enhanced stretching, rehabilitation, and strength training with this versatile incline board, perfect for targeting various muscle groups and improving flexibility and balance.

SPECIFICATIONS

↔ Measurements: 46 x 38 x 5,8 cm

🔍 Material: poplar wood

📐 Inclination: adjustable to 10°, 20°, 30°, or 40° angles

Reference code	Description	Unit
03-040002	Mambo Max adjustable wooden incline board	1 pc



Plastic incline board MD CE

Apart from stretching the calf and upper-leg muscles, the incline board is a fantastic device to improve general posture and extension in the lower back. This Incline Board is made of a composite plastic for a maximum load of 250 kg. It adjusts to 4 levels (5°, 15°, 25° and 35°) and folds flat (8 cm) to store easily. The last slot on the board makes an excellent hand-hold for stretching. The non-slip top measures 35 x 35 cm.

Reference code	Description	Unit
03-040102	Incline Board Standard	1 pc

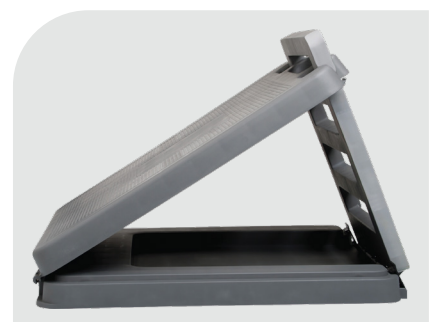

O4 Wellness



Mini massage gun CE

The Moves Mini Massage Gun is a small sized, lightweight, silent and cordless massager that can be used anywhere, anytime. Depending on your preference of frequency and force, you can adjust the intensity of your massage using the 4 speed levels.

The Moves Mini Massage Gun provides relief for muscle stiffness and soreness. Furthermore it reduces tenderness in neck, shoulders, waist and legs, while also accelerating your blood circulation.

This product comes with 5 attachments that can be switched to target specific problem areas, such as your neck, shoulders, back, legs, arms, hands and feet.

SPECIFICATIONS

↔ Measurements: 14,6 x 9,8 x 4,6 cm

🛒 Weight: 626 g

- **Speed levels:** 4
- **Motor type:** brushless motor
- **Motor:** 31,2 W / 50 dB
- **Rated speed:** 1800 - 3200 BPM
- **Amplitude:** 10 mm
- **Pressure strength:** 15 kg



- **USB-C charging cable**
- **Battery capacity:** 2600 M.Ah.



- **Charger power output:** 5V2A
- **Charge time:** 3 - 4 hours
- **Use after fully charging:** up to 4 hours



Reference code	Description	Unit
04-080101	Moves Mini Massage Gun	1 pc



1. SPHERICAL HEAD



2. BULLET HEAD

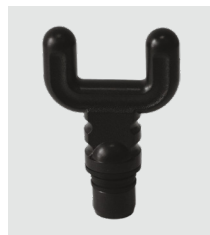

3. U-SHAPED HEAD



4. SPADE HEAD



5. PLUM BLOSSOM HEAD

1. **Spherical head** - suitable for large muscle groups such as arms, waist, hips, thighs and calves
2. **Bullet head** - suitable for deep tissues such as acupoints, tendons, joints, palms and soles of feet
3. **U-shaped head** - suitable for both sides of the spine and Achilles tendon
4. **Spade head** - suitable for relaxation and shaping of various muscle parts
5. **Plum blossom head** - suitable for deeper parts of the legs, buttocks and large areas of muscle

PACKAGING

- ✓ Cardboard packaging
- ✓ Including a convenient storage case, USB-C charging cable and 5 attachments



Triggerpoint rollers

Massage rollers are used to put pressure on muscles' triggerpoints and to loosen the tension in the muscles. Triggerpoints are often the cause of different pains.

1. SPIKY FOAM ROLLER

This product is designed for **deeper massage & acupressure** therapy. The spikes make it possible to get deeper into the muscles to relieve tension and soreness and to improve mobility. The Spiky Foam Roller has a bi-directional zone for comfort when rolling along the spine. It is mainly used for stretching, self-massage, body support and stability exercises.

SPECIFICATIONS

Length: 33 cm

Diameter: 13 cm

Reference code	Description	Unit
04-050103	Mambo Max Spiky Foam Roller	1 pc

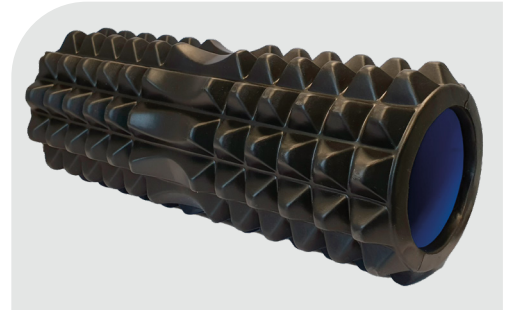

2. HOLLOW FOAM ROLLER

The Hollow Foam Roller easily helps people who are experiencing **long term pains**. Its 3-dimensional pattern with different shapes replicates the massage from a therapist's hands. The larger surfaces allow a superficial massage while the smaller shapes are meant for deeper massage.

SPECIFICATIONS

Length: 33 cm

Diameter: 14 cm

Reference code	Description	Unit
04-050101	Mambo Max Hollow Foam Roller	1 pc



3. ERGONOMIC FOAM ROLLER

The Mambo Max **Ergonomic Foam Roller** is a curved, hollow foam roller, which enables a lot of exercises. Besides rolling back and forth, it is possible to make sideways movements. More muscles will be addressed through which the body will be toned even more. The soft foam in combination with the nipples is perfect for trigger point massages. The central groove will **reduce pressure on the spine**.

SPECIFICATIONS

Length: 33 cm

Diameter: 15 cm

Reference code	Description	Unit
04-050102	Mambo Max Ergonomic Foam Roller	1 pc

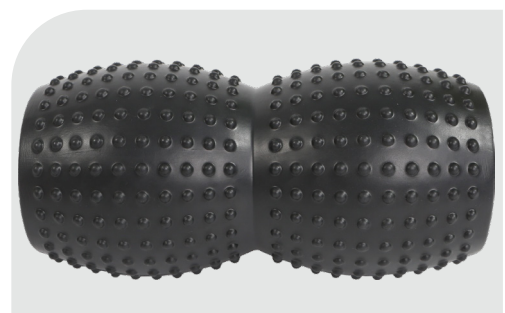



4. 3-IN-1 FOAM ROLLER

The Mambo Max 3-in-1 Foam Roller combines 3 different foam rollers in one package. Thanks to its smooth surface, the **outer part** is perfect for a superficial massage. The **second part** has grooves which can be used for a deeper massage and to exercise higher pressure on the trigger points. Finally, with the **inner massage stick** it's possible to improve blood circulation and the muscles' recovery time.

This last item, the **Mambo Max Massage Stick**, is also available as a separate product

SPECIFICATIONS

 Length: all 3 parts are 46 cm

 Diameter:

- outer part: 15 cm
- second part: 10 cm
- inner massage stick: 4 cm

Reference code	Description	Unit
O4-O5O3O1	Mambo Max 3-in-1 Foam Roller	1 set
O4-O5O2O1	Mambo Max Massage Stick	1 pc



MASSAGE STICK



IASTM tools

Moves IASTM Tools (Instrument-Assisted Soft Tissue Mobilization Tools) enable therapists to **treat acute and chronic soft tissue dysfunction**. The tools are used in physical therapy, trigger point therapy, for myofascial release and various other treatments. They can be used on many body parts, including muscles, tendons, ligaments, and fascia.

IASTM works like a standard massage, but specialized instruments are used instead of a physical therapist's hands. These instruments are designed to apply a specific amount of pressure to tissue so that a therapist can work through it without causing damage or pain to the client.

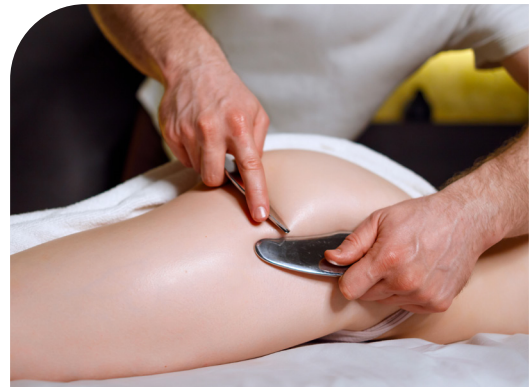

HOW TO CHOOSE THE RIGHT IASTM TOOL?

Each tool has multiple shapes and finished edges to increase its employability. The smaller ones are generally used for the treatment of smaller parts of the body, smaller strokes and reaching superficial tissue structures. The larger and heavier ones are used to reach deeper and are suitable for the treatment of larger parts of the body. Some instruments are also used to "feel" blockages by stroking/scanning across the tissue. The tips of these instruments can be either blunt or sharp, depending on the treatment given. As a general rule, the sharper the tool, the more intense and specific the soft tissue treatment. Finally, the choice of the right tool is different for every therapist. Everyone has their personal preferences and the tool should feel comfortable in one's hand. With our 6 tools, you can easily customize your treatment based on both your needs and the clients needs.

SPECIFICATIONS

- ✓ Sold as a set of 6 (different types)
- 🔍 Material: high-grade stainless steel and a brushed finish (less prone to scratches and smudges are less visible)

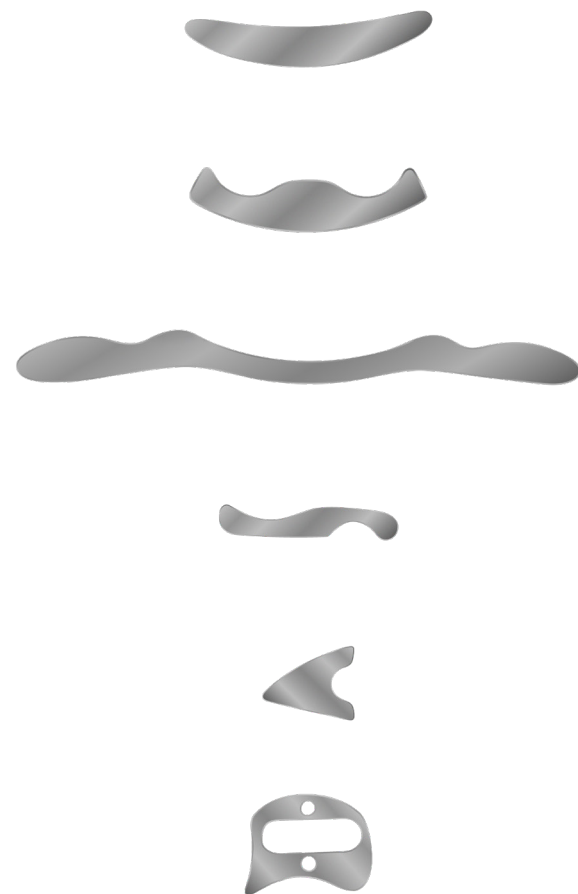

USE AND DIMENSIONS OF EACH TOOL

The first tool is ideal to work some of the **larger muscles**.
E.g. the lower leg, chest, upper arms, back, lats and upper- or lower legs.
📏 20 x 3 cm

The second instrument is often used for **medium sized areas**.
E.g. the neck, calves or pectoral muscles.
📏 19 x 4 cm

The largest tool has two handles and a round side for deep treatment. It is designed for **large muscle groups**.
E.g. the back, upper arms, hamstrings and thighs.
📏 45 x 4 cm

The fourth instrument is small, yet versatile. It's mostly used for working with **small muscles**.
E.g. the treatment of arms, shoulders, hands, feet and ankles.
📏 14 x 3 cm

This sturdy and versatile tool is perfect for **reducing tension, muscle pain and rebalancing the fascial network and body**. This tool is also useful for **scanning tissue**.
📏 7 x 6 cm

Finally, with this easy to hold tool you can treat **various muscle groups and joints**.
E.g. the hands, forearms, chest, back, upper- and lower leg.
📏 9 x 7 cm

Reference code	Description	Unit
O4-O9O111	Moves IASTM Tools	Set of 6

Massage tools

THE KNOBBLE® II

This is a massage tool made of durable polymer with a non-latex band. The Knobble® II helps you to put more pressure on the area that you want to massage. Use either the tip or the base for applying pressure on yourself or others.



THE JACKNOBBER® II

It's a massage tool that can be used in many ways to apply deep pressure to myofascial triggerpoints and areas of muscle tension. The smaller knobs provide more intense pressure, while the larger knobs give you a more diffuse pressure. Use one knob at a time to press deeply into taut bands with embedded triggerpoints. Use two knobs at a time on either side of the spine.



THE INDEX KNOBBER® II

The Index Knobber® II is a simple device designed to let you apply deep pressure to muscles within easy reach of your hand. It is the ideal instrument for clinic or home use allowing for firm, sustained pressure on targeted muscles. Its unique design allows it to be used in several hand positions and it can easily be used with both your right and left hand.



THE PALMASSAGER™

This tool is one of the most efficient massage therapy aids available anywhere. Hold it firmly in the palm of your hand and use one, two or three of its round knobs to massage sore muscles. It is used for back, shoulders, arms and legs.



THE BACKNOBBER® II

The Backnobber® II massage tool allows the user to apply as much pain-releasing pressure as they require. Remarkable effects can be achieved using this device. A locking mechanism permits it to come apart for convenient traveling and storage.

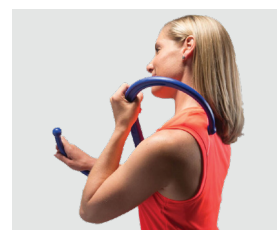

Reference code	Description	Unit
04-031101	Jacknobber II	1 pc
04-031102	Index Knobber II	1 pc
04-031103	Palmassager	1 pc
04-031104	Backnobber II	1 pc
04-031105	Knobble II	1 pc

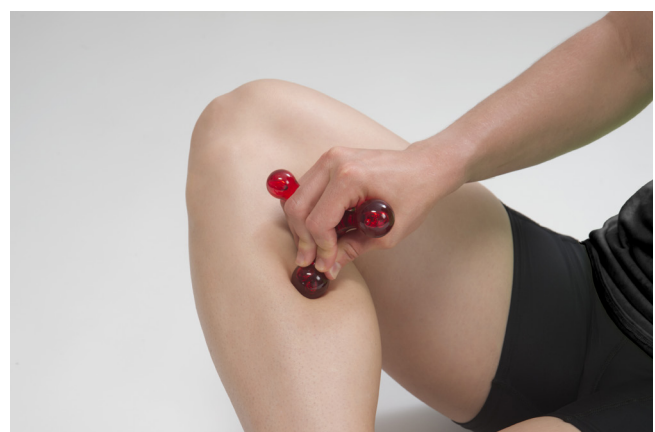

Massage ball, roll & ring

These massage tools are used for relaxing muscles and reducing tension. The Ball, Roll and Ring help to strengthen hands and feet and to improve coordination and flexibility. They can be used for massage as well as to improve dexterity skills.

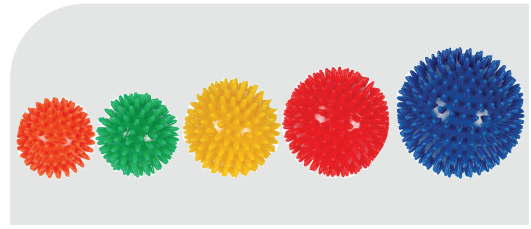

Reference code	Description	Unit
O4-O3O1O3	Mambo Max Massage Ball 6 cm	1 pc
O4-O3O1O5	Mambo Max Massage Ball 7 cm	1 pc
O4-O3O1O7	Mambo Max Massage Ball 8 cm	1 pc
O4-O3O1O9	Mambo Max Massage Ball 9 cm	1 pc
O4-O3O1I1	Mambo Max Massage Ball 10 cm	1 pc
O4-O3O121	Mambo Max Massage Roll 16 cm	1 pc
O4-O3O131	Mambo Max Massage Ring	1 pc



moves

Sport tape MD CE

The Moves Sport Tape is a non-elastic tape used **to limit motion**. The tight binding nature of the Sport Tape **decreases circulation**. This tape is made from quality cotton fibres which makes it soft and comfortable, while still providing maximum compression. The skin-friendly Moves Sport Tape is latex-free, breathable and water-resistant. The special adhesive (hypoallergenic Zinc oxide hot melt adhesive) makes sure that the tape is fixed and secure during exercise. The serrated edges make it very easy for the tape to be torn by hand.

SPECIFICATIONS

- Dimensions: 3,8 cm x 10 m
- Available in white

Reference code	Description	Unit
O4-O7O1O1	Moves Sport Tape	1 pc



moves

Kinesiology tape MD CE

Moves Kinesiology Tape is used **to facilitate motion, inhibit pain and improve circulation** while still supporting the muscles and joints. With its wave-like structure, this tape can be stretched up to 170% lengthways. This tape is also made from fine cotton fibres, which results in a soft and comfortable tape. The skin-friendly product is hypoallergenic, latex-free, breathable and water-resistant. The adhesive side is made of acrylic which prevents sweat and moisture from penetrating the tape.

SPECIFICATIONS

- Dimensions:
 - 5 cm x 5m (in all colours)
 - 5 cm x 35m (in tan)
- Available in 4 colours (tan | black | pink | light blue)

Colour	Description	Dimensions	Reference code	Unit
	Moves Kinesiology Tape Tan	5 cm x 5 m	O4-O6O1O1	1 pc
	Moves Kinesiology Tape Black	5 cm x 5 m	O4-O6O1O2	1 pc
	Moves Kinesiology Tape Pink	5 cm x 5 m	O4-O6O1O3	1 pc
	Moves Kinesiology Tape Light blue	5 cm x 5 m	O4-O6O1O4	1 pc
	Moves Kinesiology Tape Tan	5 cm x 35 m	O4-O6O1O5	1 pc



Sitting cushions

Mambo Max Sitting Cushions are air-filled cushions for active and dynamic sitting, recommended by therapists. They're easy-to-carry cushions and they activate intrinsic trunk muscles to support the spine. They relieve fatigue and adjust your posture. The surface from these sitting cushions can easily be cleaned with soap and water. All cushions can be used **as a seat** as well as **a balance trainer**.

COMFORT CUSHION 33

Soft and comfortable surface

- ↕ Height: 7 cm
- ∅ Diameter: 14 cm
- ☑ Packed in a colour box, including Needle Pump
- ☑ Packed in a polybag only, doesn't include Needle Pump



NEEDLE PUMP

Reference code	Description	Unit
O4-O2O3O1	Mambo Max Comfort Cushion 33 Blue + Needle Pump	1 pc
O4-O2O3O2	Mambo Max Comfort Cushion 33 Red + Needle Pump	1 pc
O4-O2O3O3	Mambo Max Comfort Cushion 33 Black + Needle Pump	1 pc
O4-O213O1	Mambo Max Comfort Cushion 33 Blue In polybag	1 pc
O4-O213O2	Mambo Max Comfort Cushion 33 Red In polybag	1 pc
O4-O213O3	Mambo Max Comfort Cushion 33 Black In polybag	1 pc



STANDARD CUSHION 37

One smooth side | One senso side (with knobs)

- ↕ Height: 7 cm
- ∅ Diameter: 38cm
- ☑ Including Faster Blaster pump

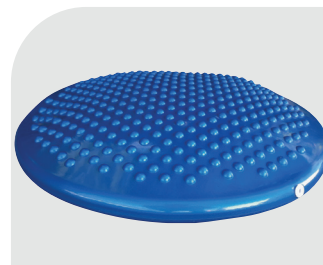

FASTER BLASTER PUMP

Reference code	Description	Unit
O4-O2O1O3	Mambo Max Standard Cushion 37 + Faster Blaster Pump	1 pc



STANDARD CUSHION 33

One smooth side | One senso side (with knobs)

- ↕ Height: 7 cm
- ∅ Diameter: 33cm
- ☑ Including Needle Pump



SMOOTH SIDE

Reference code	Description	Unit
O4-O2O1O1	Mambo Max Standard Cushion 33 + Needle Pump	1 pc



SENSAIR CUSHION

One smooth side | One senso side (with knobs)

- ↕ Height: 7 cm
- ∅ Diameter: 31cm
- ☑ Including Needle Pump



SMOOTH SIDE

Reference code	Description	Unit
O4-O2O1O2	Mambo Max SensAir Cushion + Needle Pump	1 pc



SITTING WEDGE

One smooth side | One senso side (with knobs)

- ↕ Height: 7 cm
- Width: 34cm
- ☑ Including Faster Blaster Pump



SMOOTH SIDE

Reference code	Description	Unit
O4-O2O2O1	Mambo Max Sitting Wedge + Faster Blaster Pump	1 pc



Adjustable ball chair

The Mambo Max adjustable ball chair offers you the ideal way to upgrade your work setup. This chair enables active sitting throughout the day. That way, you put an end to sedentary behavior in the workplace or at home. The ergonomic back support assists with spine alignment, it strengthens the core, and it corrects your sitting posture.

Inflation options for your ball chair (choose the option that suits you best for optimal comfort):

1. **Plug:** Quick and easy to use, though the chair may soften slightly over time.
2. **Valve:** For lasting firmness, use the valve with a needle pump (sold separately) to prevent deflation.

SPECIFICATIONS

- Instability-induced motion helps to firm your core, improve circulation and posture
- Chair height ranges from 51 cm to 58 cm (20" to 23") to fit most standard desks
- Stable, 360° swivel base allows for easy movement
- Lightweight and compact
- Lockable easy glide caster wheels
- Anti-burst, removable oval-shaped ball seat, different from other ball chairs
- Max weight: 127 kg (280 lbs)
- Comes with a straw to blow up the ball cushion

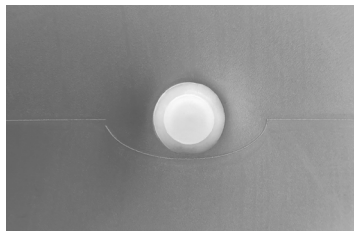

INFLATION OPTION 1 PLUG

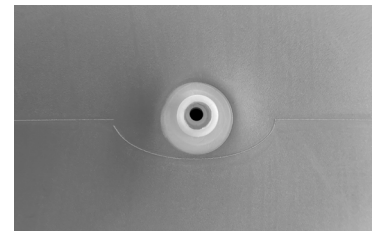

INFLATION OPTION 2 VALVE

Colour	Description	Reference code	Unit
	Mambo Max Adjustable Ball Chair Black / Grey ball	O4-O2O4O1	1 pc

Pilates

FOAM ROLLER

The Mambo Max Foam Roller is used for Pilates training and spine exercises, more specifically back aches. It's ideal for balance and stabilisation exercises. Foam rollers are used for stretch and strength exercises, as well as for massage and relaxation.

SPECIFICATIONS

- ↔ Length: 45 cm | 90 cm
- ∅ Diameter: 15 cm
- 🔍 Material: EVA foam (soft, yet durable polymer of ethylene and vinyl acetate)



Reference code	Description	Size	Unit
O4-O1O1O2	Mambo Max Pilates Foam Roller EVA	90 cm	1 pc
O4-O1O1O4	Mambo Max Pilates Foam Roller EVA	45 cm	1 pc

SOFT-OVER-BALL

The Mambo Max Soft-Over-Ball is an inflatable ball used for resistance work in Pilates. It is a wonderful tool for adding focus and energy to your workouts. In addition, when slightly deflated, it can be used as a soft prop under the head, neck, feet, back...

Now available in 3 different colours and sizes, giving you a range of 9 Soft-Over-Balls

Reference code	Description	Size	Unit
O4-O1O105		17 - 19 cm	1 pc
O4-O1O115	Mambo Max Pilates Soft-Over-Ball Green	21 - 23 cm	1 pc
O4-O1O125		25 - 27 cm	1 pc



Reference code	Description	Size	Unit
O4-O1O113		17 - 19 cm	1 pc
O4-O1O123	Mambo Max Pilates Soft-Over-Ball Blue	21 - 23 cm	1 pc
O4-O1O103		25 - 27 cm	1 pc



Reference code	Description	Size	Unit
O4-O1O107		17 - 19 cm	1 pc
O4-O1O117	Mambo Max Pilates Soft-Over-Ball Black	21 - 23 cm	1 pc
O4-O1O127		25 - 27 cm	1 pc



RING

The Mambo Max Pilates Ring is a resistive ring with foam padded grips. This product is used for exercises focusing on strength, balance, flexibility and posture. The ring adds light resistance to Pilates exercises and helps to target specific muscle groups. It's often used to help tone the arms and thighs, and to increase the core strength challenge of an exercise

SPECIFICATIONS

- ∅ Diameter: 38 cm
- 🔍 Material: foam covered fiberglass

Reference code	Description	Unit
O4-O1O101	Mambo Max Pilates ring	1 pc



Stepping stones

The non-slip Mambo Max Stepping Stone is an amazing tool to freshen up and enhance your workout. It can be used by both children and adults for indoor and outdoor activities to improve dynamic balance, body awareness and coordination. These Stepping Stones can also serve as a foot massage tool while you're seated.

SPECIFICATIONS

- Ø Diameter: 16 cm
- ✓ Vivid colours: yellow, orange, red, purple, blue and green
- ✓ 6 pcs of a different colour packed in a cardboard box

Reference code	Description	Unit
O4-O30141	Mambo Max Stepping Stone	6-pack



Yoga

Mambo Max offers different Yoga items. These can be bought separately or in a Yoga Set. The set consists of the following products:

- 1 PVC yoga mat | 173 x 61 x 0,4 cm
- 2 EVA foam yoga blocks | 7,5 x 15 x 23 cm
- 1 yoga strap with buckle | 180 x 3,8 cm

Reference code	Description	Unit
O4-O10201	Mambo Max Yoga Mat	1 pc
O4-O10202	Mambo Max Yoga Block	5-pack
O4-O10203	Mambo Max Yoga Strap	1 pc
O4-O10211	Mambo Max Yoga Set 1 Mat 2 Blocks 1 strap	Set

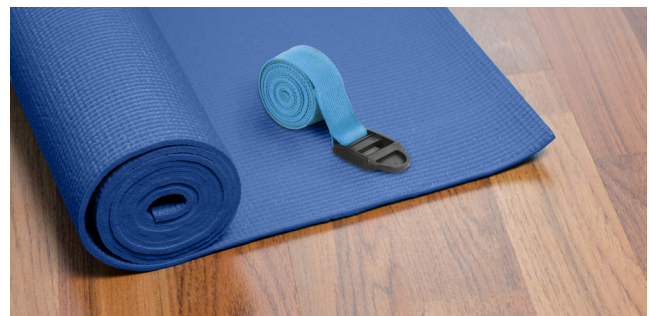
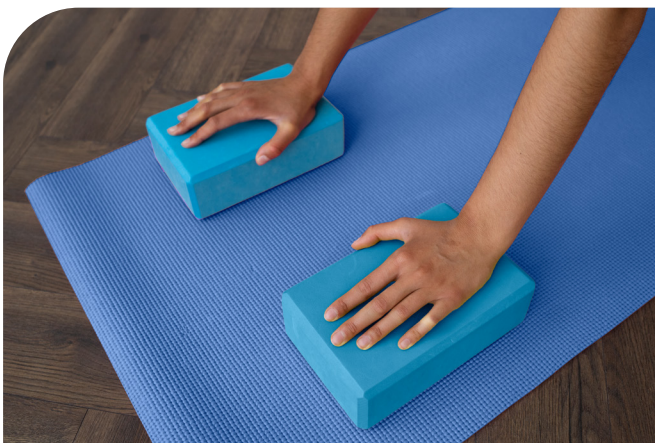

O5 Fitness

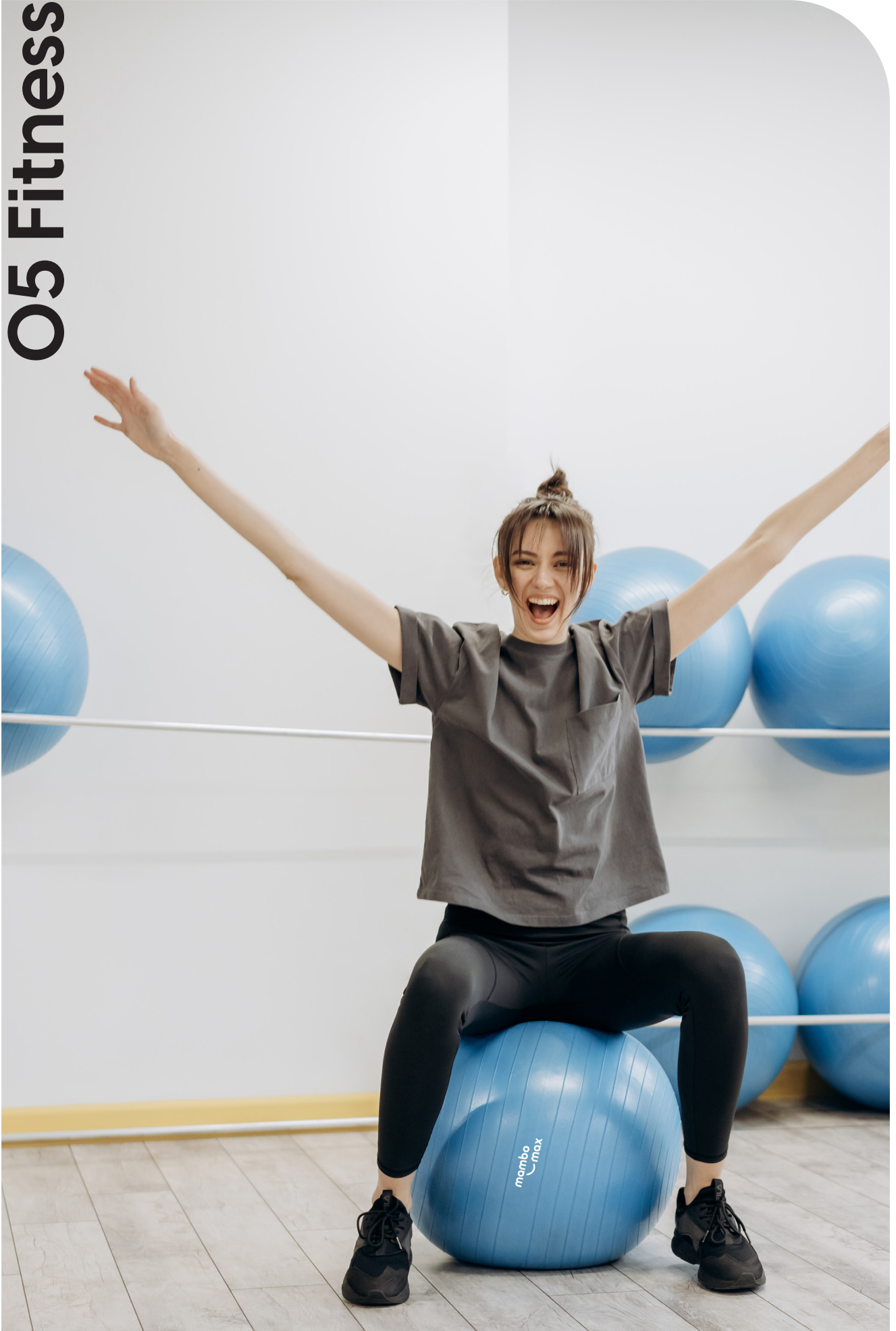

Gym mat

Mambo Max Gym Mats provide a soft touch and comfortable exercise environment. They are perfect for gym & fitness. They have a non-slip, well-cushioned surface with a unique closed cell structure. The mats are equipped with plastic rings that are 40 cm apart so they can be suspended while not in use. Mambo Max also offers a Gym Mat Wall Hanger that can hold up to 10 mats.

The Mambo Max Gym Mats are available in 3 different sizes and thicknesses. They are **latex-free** and can be used in water. Each mat comes with a handy **storage/carry strap**.

COMFORT GYM MAT

measurements: 140 x 60 x 1 cm

colours: and



XTRA COMFORT GYM MAT

measurements: 180 x 60 x 1,5 cm

colours: and and and

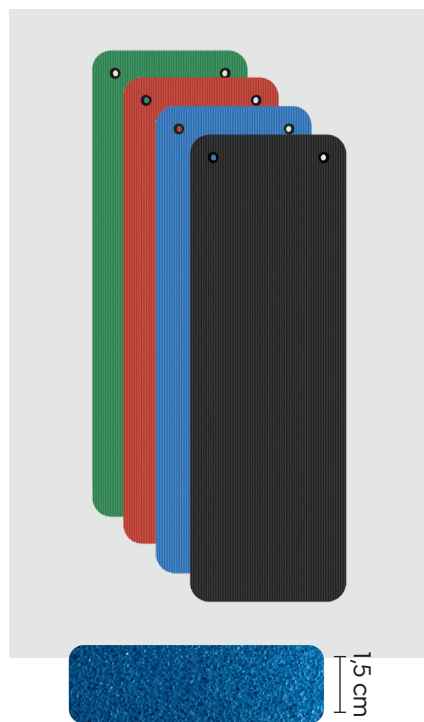

XTRA COMFORT GYM MAT

measurements: 180 x 100 x 1,5 cm

colours: and and

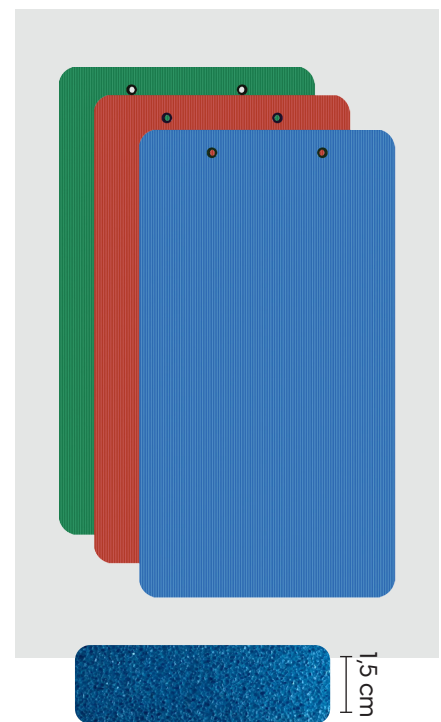

Reference code	Description	Unit
05-030001	Mambo Max Gym Mat Wall Hanger For 10 mats	1 pc
05-030303	Mambo Max Comfort Gym Mat 140 x 60 x 1 cm Rings Strap	1 pc
05-030304	Mambo Max Comfort Gym Mat 140 x 60 x 1 cm Rings Strap	1 pc
05-030101	Mambo Max Xtra Comfort Gym Mat 180 x 60 x 1,5 cm Rings Strap	1 pc
05-030102	Mambo Max Xtra Comfort Gym Mat 180 x 60 x 1,5 cm Rings Strap	1 pc
05-030103	Mambo Max Xtra Comfort Gym Mat 180 x 60 x 1,5 cm Rings Strap	1 pc
05-030104	Mambo Max Xtra Comfort Gym Mat 180 x 60 x 1,5 cm Rings Strap	1 pc
05-030201	Mambo Max Xtra Comfort Gym Mat 180 x 100 x 1,5 cm Rings Strap	1 pc
05-030202	Mambo Max Xtra Comfort Gym Mat 180 x 100 x 1,5 cm Rings Strap	1 pc
05-030203	Mambo Max Xtra Comfort Gym Mat 180 x 100 x 1,5 cm Rings Strap	1 pc

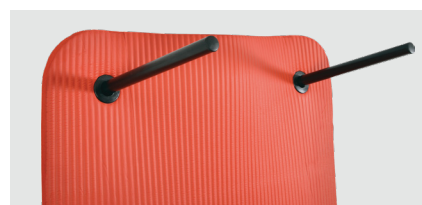



Aerobic step

Step aerobics is a form of aerobics that is practiced worldwide by millions of people. The reason for its popularity is simple, it offers a great cardio workout without the need for extensive space or equipment.

Furthermore, it's low impact and it doesn't stress the joints as much as running or jogging.

The height of the Mambo Max Aerobic Step is adaptable, which allows you to **adjust the intensity** of the work-out according to your preferences.

SPECIFICATIONS

Measurements: 96 x 33 cm

Height can be altered to **15 / 20 / 25 cm** by using blocks underneath the step

100 kg

Reference code	Description	Unit
O5-070101	Mambo Max Aerobic Step	1 pc



15 CM



20 CM



25 CM

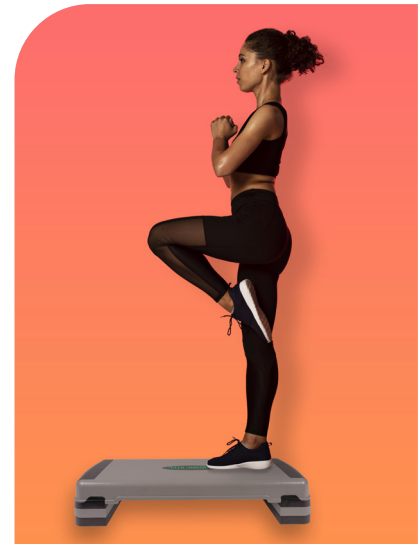

Fabric elastic band

The Mambo Max Fabric Elastic Band consists of 10 consecutive loops. This great toning and workout tool is suitable for every kind of athlete, whether you're a beginner or a professional. There are 3 different resistances available, while the 10 consecutive loops allow you to spice things up as well. Intensify your physical training by using a lower amount of consecutive loops resulting in a higher resistance.

This product is durable and extremely versatile. You can use it for stretching, toning or even as an alternative for dumbbells as a weight training accessory.

SPECIFICATIONS

Total length: 120 cm
1 loop length: 11,5 cm

Resistance: available in 3 different levels

Colour	Resistance	Reference code	Unit
	Red Light 7 kg	O5-120107	1 pc
	Green Medium 10 kg	O5-120110	1 pc
	Blue Heavy 15 kg	O5-120115	1 pc



Balance board

The Mambo Max Balance Board is an effective tool for balance training and fitness exercises. Stand on the rounded platform and start balancing. It is also a great tool to strengthen your ankles and thigh muscles. For a more severe balance training, add the included screw-on top to your Mambo Max Balance Board.

SPECIFICATIONS

∅ Diameter: 42 cm

↕ Height: 5 - 8 cm



Reference code	Description	Unit
O5-O4O2O1	Mambo Max Balance Board	1 pc

Wooden balance boards

These Balance Boards are the ideal solution if you want to improve your balance on an **ecologic, high-end product**. They are often used for proprioception training, which challenges and develops proprioceptive receptors. Proprioception helps to stabilise a joint during static and dynamic functional tasks. Proprioception exercises can decrease your risk of injury.

The Wooden Balance Board is available in 3 versions: Uni-Directional, Standard & Sport. Thanks to their different form and balance point, these products have a very different character and level of difficulty.

UNI-DIRECTIONAL

This board offers a **more predictable** and **confident training** as it can only pivot in 1 direction. Making it ideal for children and elderly to improve body stability without the fear of falling. When turning this board upside-down, the arches can be used as push-up grips.

□ Measurements: 40 x 40 cm

↕ Height: 10 cm



STANDARD

The Balance Board Standard is lower than the Sport version. In addition, with its **smoother pivot point**, it reacts completely different than the Sport. It's a great middle step between the Uni-Directional and Sport Balance Boards.

□ Measurements: 40 x 40 cm

↕ Height: 6 cm

△ Max inclination: 12,5°



Reference code	Description	Unit
O5-O4O0O1	Mambo Max Wooden Balance Board - Standard	1 pc
O5-O4O0O3	Mambo Max Wooden Balance Board - Uni-directional	1 pc



Balance board freeman

The Mambo Max Balance Board Freeman is ideal for balance training. Stand on the rounded platform and start balancing. This is a great way to strengthen your ankles and thigh muscles. The handgrips can be used for upper body balancing and workouts.

SPECIFICATIONS

∅ Diameter: 40 cm

↕ Height: 8 cm



Reference code	Description	Unit
O5-O4O2O2	Mambo Max Balance Board Freeman	1 pc



Body twister

If you're looking for a tool to **slim your thighs, waist and hips**, the Mambo Max Body Twister is the answer! While twisting your body, the disc below your feet turns. This trains your glutes, abdominals and legs. Continue to twist your body from side to side to tone all the muscles in your body. Furthermore, the Mambo Max Body Twister is an effective product to **enhance balance and coordination**.

SPECIFICATIONS

∅ Diameter: 25 cm

↕ Height: 3 cm



Reference code	Description	Unit
O5-100101	Mambo Max Body Twister	1 pc



Ekilibre

The Mambo Max Balance Plate "Ekilibre" is designed for balance training. **Combining balance pad with balance board**, it offers the best of both worlds. It improves your sense of equilibrium, coordination, reaction and motor skills. It can be used for lying, kneeling, sitting and stepping movement and it can be incorporated with other exercise equipment.

Reference code	Description	Unit
O5-O4O5O1	Mambo Max Ekilibre Beginner	1 pc
O5-O4O5O2	Mambo Max Ekilibre Intermediate	1 pc

BEGINNER



□ Measurements:
60 x 39 cm

↕ Height: 9 cm



INTERMEDIATE

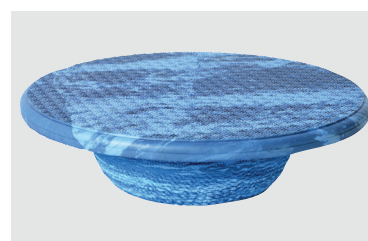

∅ Diameter: 39 cm

↕ Height: 9 cm



Balance trainer

The Mambo Max Balance Trainer is used to improve your sense of equilibrium, coordination, reaction and motor skills. It is also ideal for muscle exercise. You can adjust the Balance Trainer by inflating and deflating the air through the valve. You can use it for kneeling, sitting and stepping movement. To spice up your rehabilitation, incorporate this product with other exercise equipment.



∅ Diameter: 45 cm

↕ Height: 16 cm

🔍 2 equal sides

🧑 100 kg



∅ Diameter: 60 cm

↕ Height: 14 cm

🔍 1 smooth side
1 senso side

🧑 100 kg

Reference code	Description	Unit
05-040102	Mambo Max Balance Trainer 45 cm	1 pc
05-040103	Mambo Max Balance Trainer 60 cm	1 pc

Balance pad

This **EVA-foam** Balance pad provides the comfortable exercise environment needed to perform reinforcing balance exercises. Its soft and consequently unstable surface challenges the user to work the foot-, ankle-, and leg muscles.

AVAILABLE IN 3 VERSIONS:



Rectangular shaped pad.

📏 Measurements: 50 x 40 x 6 cm

● Colour: Blue



Rectangular shaped pad.

📏 Measurements: 50 x 40 x 6 cm

● Colour: Anthracite



2 Oval shaped pads, sold per pair.

📏 Measurements: 36 x 22 x 6 cm

● Colour: Blue

Reference code	Description	Unit
05-040301	Mambo Max Balance Pad Blue	1 pc
05-040303	Mambo Max Balance Pad Anthracite	1 pc
05-040302	Mambo Max Balance Pad Oval Blue	Pair

Balance pad pro

This Balance Pad is a great training tool to improve your balance, stability, flexibility, strength and motor skills. The Balance Pad Pro **creates more instability** than our regular one, so you constantly need to correct body posture, making the exercises just that bit tougher. This Balance Pad is made out of **PU-material** instead of EVA-foam (which most balance pads are made from), which makes it **more durable** and less prone to small damages and wear.

SPECIFICATIONS

Measurements: 40 x 50 x 6 cm

Reference code	Description	Unit
05-040304	Mambo Max Balance Pad Pro Rectangular Blue	1 pc



AB gym ball

The Mambo Max **AB (Anti-Burst)** gym ball increases flexibility, improves strength, fitness and posture. Exercising with this ball also enhances your balance and coordination. All AB gym balls are Anti-Burst: if the ball gets punctured by a sharp object, the ball won't burst, thus reducing the risk of an injury.

SPECIFICATIONS

Available in 6 different sizes

Material: ecofriendly PVC

(Heavy metal content in compliance with EN 71 Standards.
Phthalates content meets EU-directive 2005/84/EC)

200 kg

PACKAGING

- 1 AB gym ball in a cardboard retail pack
- Includes: Faster Blaster Pump, Exercise Chart, Plug and Plug Remover
- Value pack: a polybag containing only the ball and plug



Colour	Ball Size	Body Height	Mambo Max AB gym ball		Unit
			Box + Pump	Polybag	
	45 cm	< 125 cm	05-010102	n/a	1 pc
	55 cm	125 - 150 cm	05-010103	05-010203	1 pc
	65 cm	150 - 175 cm	05-010104	05-010204	1 pc
	75 cm	175 - 185 cm	05-010105	05-010205	1 pc
	85 cm	185 - 200 cm	05-010106	n/a	1 pc
	95 cm	> 200 cm	05-010107	n/a	1 pc

AB peanut ball

The Mambo Max **AB (Anti-Burst)** Peanut Ball helps **users who struggle with the instability** of a regular gym ball. The peanut shape offers extra sideways stability, which gives more confidence to start working out with gym balls.

The Mambo Max AB Peanut Ball offers a more predictable therapy or fitness training as it can only roll in one direction. This certainly is a huge benefit for children, elderly or people who suffered an injury. In addition, peanut balls are very popular amongst pregnant women and are very helpful devices during labour.

PACKAGING

- ✔ 1 AB Peanut Ball in a cardboard retail pack
- ✔ Includes: Faster Blaster Pump and plug.



Colour	Peanut Ball Size	Mambo Max AB Peanut Ball + Pump	Unit
●	50 x 100 cm	05-011103	1 pc

Dynadome

Half sphere, inflatable exercise dome. This versatile product enables the user to perform exercises on both sides of the product, allowing it to be used for a full body workout as well as for balance exercises. Basically, it's Mambo Max's economical answer to the expensive balance trainers on the market, but **with extra tubing and handles!**

SPECIFICATIONS

- ∅ Diameter: 59 cm
- ↕ Height: 21 - 25 cm
- ✔ Includes: **Faster Blaster Pump**
- ✔ Includes: **Tubing with handles**



Reference code	Description	Unit
05-040401	Mambo Max Dynadome Tubing with handles Faster Blaster Pump	1 pc



Ball accessories



ELECTRIC COMPRESSOR PUMP

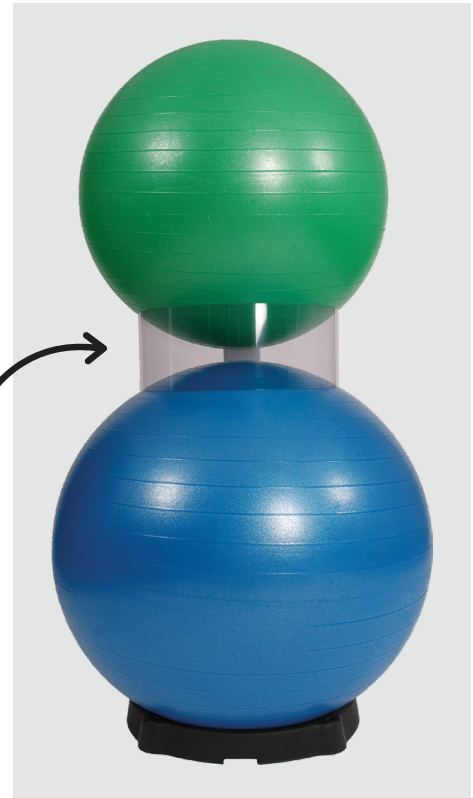

BALL STACKER WITH VELCRO CLOSURE



HAND PUMP



FASTER BLASTER PUMP



NEEDLE PUMP



FOOT PUMP



BALL STABILISER THAT FACILITATES BALANCE. ITS NOTCHES ENABLE COMBINED AB GYM BALL / MOVES BAND EXERCISES.

Reference code	Description	Unit
O5-O20101	Mambo Max Ball Stabiliser	1 pc
O5-O20102	Mambo Max Ball Stacker	3 pcs
O5-O20201	Mambo Max Faster Blaster Pump 2 x 120 cc	1 pc
O5-O20202	Mambo Max Hand Pump 2 x 2000 cc	1 pc
O5-O20203	Mambo Max Needle Pump 100 cc	1 pc
O5-O20204	Mambo Max Foot pump	1 pc
O5-O20205	Electric Compressor Pump	1 pc

O6 Strength

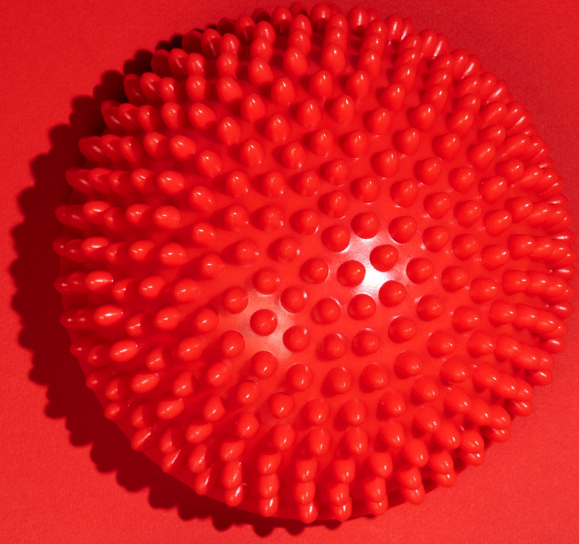

SoftMeds

Mambo Max SoftMeds are colour coded hand weighted balls that are small and flexible enough to grasp with one hand, yet big enough to hold with both hands. The soft, pliable vinyl cover makes it easy to hold and is a safe and effective way to add weight training to your workout.

Mambo Max SoftMeds are fully inflated and ready to use, straight out of the box! When needed, air pressure can be adjusted with a needle pump.

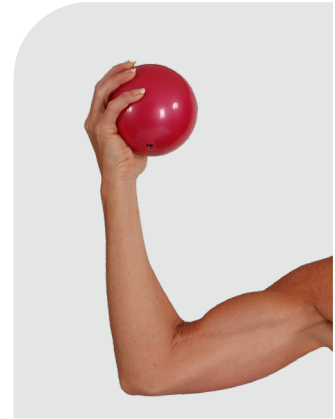

SPECIFICATIONS

∅ Diameter: 12 cm

Reference code	Weight	Description	Colour	Unit
O6-O4O1O2	0,5 kg	Mambo Max SoftMeds Tan		1 pc
O6-O4O1O3	1,0 kg	Mambo Max SoftMeds Yellow		1 pc
O6-O4O1O4	1,5 kg	Mambo Max SoftMeds Red		1 pc
O6-O4O1O5	2,0 kg	Mambo Max SoftMeds Green		1 pc

Coated dumbbell

Mambo Max Dumbbells are cast iron weights, coated with vinyl or neoprene. The vinyl coating is easy to wash or can be treated with a water based disinfectant. The neoprene coating has an added resin to give them a scrubby feel and superior grip.

SPECIFICATIONS

- ✓ Available in 7 different weights + matching colour code
- ✓ The Dumbbell Rack can hold 6 Dumbbells



NEOPRENE DUMBBELLS



RACK WITH VINYL DUMBBELLS

Description	Colour	Weight	Reference code		Unit
			Vinyl	Neoprene	
Mambo Max Dumbbell Pink		0,5 kg	O6-O1O1O2	O6-O1O2O2	pair
Mambo Max Dumbbell Yellow		1,0 kg	O6-O1O1O3	O6-O1O2O3	pair
Mambo Max Dumbbell Red		1,5 kg	O6-O1O1O4	O6-O1O2O4	pair
Mambo Max Dumbbell Green		2,0 kg	O6-O1O1O5	O6-O1O2O5	pair
Mambo Max Dumbbell Blue		3,0 kg	O6-O1O1O7	O6-O1O2O7	pair
Mambo Max Dumbbell Black		4,0 kg	O6-O1O1O8	O6-O1O2O8	pair
Mambo Max Dumbbell Grey		5,0 kg	O6-O1O1O9	O6-O1O2O9	pair
Mambo Max Dumbbell Rack (empty)				O6-0001O1	1 pc

Medicine ball

A Medicine Ball (also known as an exercise ball, a med ball, or a fitness ball) is often used for strength training. It is used for rehabilitation from an injury and therefore plays an important role in the field of **sports medicine**.

Moreover, it is the ideal attribute for training multiple muscle groups because of the combination of cardio and strength training.

Medicine ball training is one of the oldest forms of strength and conditioning training.

SPECIFICATIONS

Rack measurements: 28 x 60 x 173 cm (L x W x H)

Reference code	Description	Weight	Ø	Colour	Unit
O6-O3O1O3	Mambo Max Medicine Ball Yellow	1 kg	20 cm		1 pc
O6-O3O1O4	Mambo Max Medicine Ball Red	1,5 kg	20 cm		1 pc
O6-O3O1O5	Mambo Max Medicine Ball Green	2 kg	20 cm		1 pc
O6-O3O1O7	Mambo Max Medicine Ball Blue	3 kg	22 cm		1 pc
O6-O3O1O8	Mambo Max Medicine Ball Black	4 kg	22 cm		1 pc
O6-O3O1O9	Mambo Max Medicine Ball Grey	5 kg	27 cm		1 pc
O6-O0O3O1	Mambo Max Medicine Ball Rack (empty)				1 pc



Kettlebell

The Mambo Max Kettlebells are an important part of any fitness or CrossFit training. Made from excellent iron surrounded with a colourful vinyl coating, they will not damage any surfaces when being stored. Starting from 2 kg up to 24 kg, we also offer you a complete set, including a premium quality Kettlebell Rack. This rack can hold up to 150 kg per shelf (total of 300 kg).

SPECIFICATIONS

Rack measurements: 120 x 50 x 70 cm (L x W x H)



Reference code	Description	Weight	Colour	Unit
O6-O5O1O2	Mambo Max Kettlebell Sky Blue	2 kg		1 pc
O6-O5O1O4	Mambo Max Kettlebell Purple	4 kg		1 pc
O6-O5O1O6	Mambo Max Kettlebell Yellow	6 kg		1 pc
O6-O5O1O8	Mambo Max Kettlebell Red	8 kg		1 pc
O6-O5O110	Mambo Max Kettlebell Green	10 kg		1 pc
O6-O5O112	Mambo Max Kettlebell Blue	12 kg		1 pc
O6-O5O116	Mambo Max Kettlebell Black	16 kg		1 pc
O6-O5O120	Mambo Max Kettlebell Silver	20 kg		1 pc
O6-O5O124	Mambo Max Kettlebell Orange	24 kg		1 pc
O6-O51O01	Mambo Max Kettlebell Rack (empty)			1 pc
O6-O511O1	Mambo Max Kettlebell Set + Rack			Set



Wrist & ankle weights

To quickly build stamina and muscle, simply add Mambo Max Wrist and Ankle Weights to your workout. They are filled with iron sand and they have a soft and comfortable nylon finishing. These Mambo Max Wrist and Ankle Weights will effectively shape and tone your body and you can wear them anywhere! Wear them around the office, out shopping or at the gym.



0,5 - 2 KG

Reference code	Description	Weight	Unit
O6-O2O1O2	Mambo Max Wrist & Ankle Weights	0,5 kg	Pair
O6-O2O1O3	Mambo Max Wrist & Ankle Weights	1 kg	Pair
O6-O2O1O4	Mambo Max Wrist & Ankle Weights	1,5 kg	Pair
O6-O2O1O5	Mambo Max Wrist & Ankle Weights	2 kg	Pair
O6-O2O1O7	Mambo Max Wrist & Ankle Weights	3 kg	Pair
O6-O2O1O8	Mambo Max Wrist & Ankle Weights	4 kg	Pair
O6-O2O1O9	Mambo Max Wrist & Ankle Weights	5 kg	Pair



3 - 5 KG



Premium wrist & ankle weights

Complete your gym set and enhance your work out with these trendy wrist and ankle weights. With the premium Mambo Max wrist and ankle weights you can easily train your arm and leg muscles. You can build up the weights or simply challenge yourself during exercising. Available in 3 different weights, each with a particular colour:

- Light grey: 0,5 kg
- Grey: 1 kg
- Anthracite: 1,5 kg

SPECIFICATIONS

- Available in 3 different weights: 0,5 kg | 1 kg | 1,5 kg
- Pair of the chosen weight comes in a colourbox

Description	Reference code	Unit
Wrist & ankle weights 0,5 kg Light grey	O6-O6O1O1	pair
Wrist & ankle weights 1 kg Grey	O6-O6O1O2	pair
Wrist & ankle weights 1,5 kg Anthracite	O6-O6O1O3	pair



Thumb lock wrist weight

The Mambo Max Thumb Lock Wrist Weight enables you to fix the weight to your thumb, ensuring a fixed position during your entire workout. Whether you're boxing, running or doing Zumba, the weights will remain in place!



Reference code	Description	Weight	Unit
O6-O2O2O2	Mambo Max Thumb Lock Wrist Weights	0,5 kg	Pair

07 Thermal

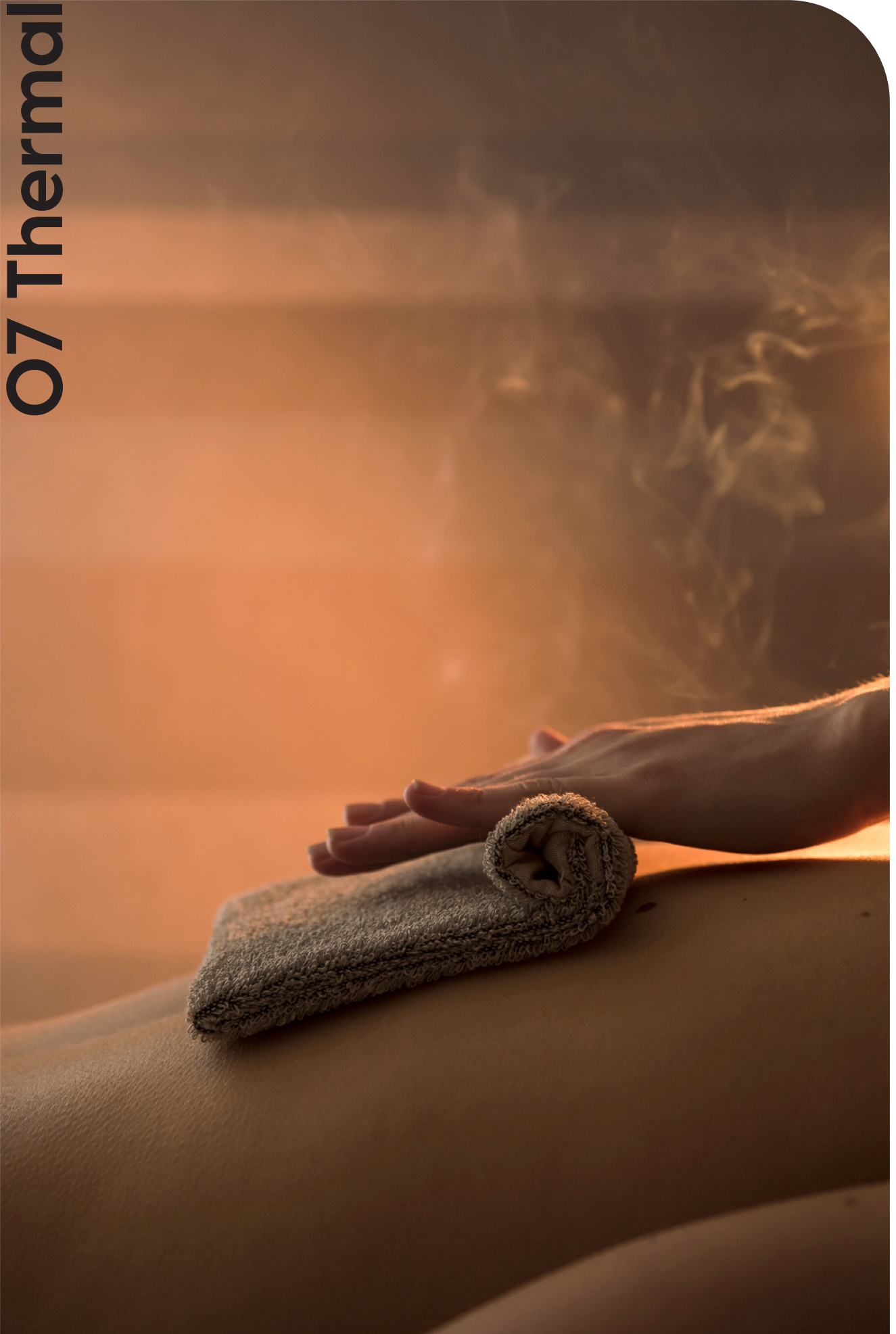

Para Pro - paraffin bath CE

The Para Pro is a professional paraffin wax heating bath. Treatment with the Moves Para Pro Bath reduces arthritis in the joints, and it also relaxes the muscles. Additionally, the paraffin wax provides deep hydration and nourishment, quickly leaving your hands and feet soft and healthy.

SPECIFICATIONS | PARA PRO

- ❶ • Outer dimensions: 39 x 25 x 18 cm (L x W x H)
 - Inner dimensions: 32,5 x 18 x 13 cm (L x W x H)
 - Weight: 3,1 kg
 - 220/230 V: No transformer needed, which will lengthen the durability
 - Low power consumption once the paraffin has melted
 - 24-hours a day fully operational
 - Fast melting between 2-3 hours !
 - Adjustable temperature (40 - 60°C)
 - Digital thermometer
- ✔ Comes with UK or EU plug!



SPECIFICATIONS | PARAFFIN PEARLS

- ❶ • White fully refined paraffin wax
 - Congealing point: 53°C
 - Melting point: +/- 52-54°C
 - Odourless
 - Meets the purity requirements of BGA1, Ph.EUR.2 and FDA3
1. Bundesgesundheitsamt recommendation No. XXV B II
 2. European Pharmacopoeia, current edition
 3. Food and Drug Administration, § 172.886 Petroleum Wax



PARAFFIN PEARLS

SPECIFICATIONS | PARAFFIN BLOCKS

- ❶ • Green fully refined paraffin wax
- Melting point: 46°C
- Tea tree scented



HEAT HOLDING GLOVES

Includes heat holding gloves & 10 pairs of disposable gloves

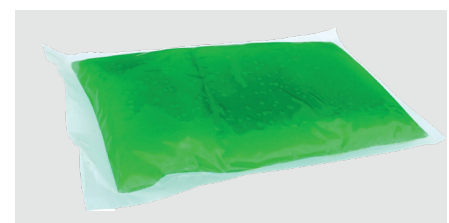

PARAFFIN BLOCK

Reference code	Description	Unit
07-100101	Moves Para Pro Bath + 2,5 kg Paraffin Pearls white EU-plug	1 pc
07-100101 UK	Moves Para Pro Bath + 2,5 kg Paraffin Pearls white UK-plug	1 pc
07-100206	Moves Para Pro Bath + Set of 6 Paraffin Blocks 46°C (2,72 kg) tea tree green EU-plug	1 pc
07-100206 UK	Moves Para Pro Bath + Set of 6 Paraffin Blocks 46°C (2,72 kg) tea tree green UK-plug	1 pc
07-110102	Moves Paraffin Pearls - 2,5 kg 52-54 dab	1 pc
07-110125	Moves Paraffin Pearls - 25 kg 52-54 dab	1 pc
07-110206	Moves Paraffin Blocks 46° Set of 6 x 453 g (2,72 kg) tea tree green	1 pc
07-109801	Moves Insulating gloves for Para Pro Bath blue	1 pair
07-109802	Moves Disposable Gloves for Para Pro Bath	10 pairs

New: Moist heat therapy by Moves CE

Constructed of seamless, stainless steel, a moist heat unit is a stationary or mobile thermostatically controlled liquid heating device. Once heat packs are inserted into the water inside, the unit heats them up to maximum 76°C. From here, the health professional removes the pack to wrap it in a cover (or towels) and applies it to the area being treated. The packs themselves draw in the heat to hold their temperature. This treatment assists with pain management, addressing spasms, improving a patient’s range of motion and loosening tight, contracted muscles before a massage, physical therapy or athletic training session or chiropractic adjustment.

MOIST HEAT PACK UNITS

The unit heats moist heat packs up in a water bath up to 76°C. We offer 4, 6 and 12-pack unit capacity. Each Moves moist heat pack unit is made from durable seamless, stainless steel which makes them easy to clean. All heating units are fully insulated. This insulation prevents the exterior from becoming too hot and it keeps the temperature of the heating unit inside.

MOIST HEAT PACKS

The moist heat packs are easy to heat up and they retain the moist heat for up to 30 minutes. They’re reusable and can be used with a cover or a towel.

MOIST HEAT PACK COVERS

We also offer moist heat pack covers, to cover a hot pack. These are reusable and washable.



HEATING UNIT | 4-PACK CAPACITY | STATIONARY



HEATING UNIT | 6-PACK CAPACITY | STATIONARY



HEATING UNIT | 12-PACK CAPACITY | MOBILE



MOIST HEAT PACKS



STANDARD COVER



CERVICAL COVER

Reference code	Description	Unit
O7-200101	Relief Pak by Moves heating unit 4-pack stationary w/o packs 220V	1 pc
O7-200102	Relief Pak by Moves heating unit 6-pack stationary w/o packs 220V	1 pc
O7-200103	Relief Pak by Moves heating unit 12-pack mobile w/o packs 220V	1 pc
O7-200201	Moves Moist heat pack standard 25 x 30cm	1 pc
O7-200202	Moves Moist heat pack neck 60 cm	1 pc
O7-200203	Moves Moist heat pack spine small 25 x 45cm	1 pc
O7-200301	Moves Moist heat pack cover standard (for standard and spine small)	1 pc
O7-200302	Moves Moist heat pack cover cervical (for neck)	1 pc

Hot/cold pack MD CE

The Moves Hot/Cold Packs are used for hot as well as cold therapy. This dual applicability makes them a strong alternative to ordinary heating pillows and ice packs. The versatile, reusable packs deliver therapy effectively and economically. The use of the Moves Hot/Cold Pack is unlimited and its material is non-toxic. Even below -20°C it remains soft. The Moves Hot/Cold Pack can be bent in any angle, allowing maximum coverage of joint and muscle. All Hot/Cold Packs can be heated (microwave) and can be frozen (freezer). The temperature holds for approximately 30 minutes.

CLASSIC - GEL

The classic (and economical) transparent Hot/Cold Pack. The special gel is non-toxic and biodegradable.

✔ Sold per 10 pcs

🏠 For home use only!



STANDARD - GEL

Our standard Hot/Cold Pack is a nylon covered gelpack. The special gel is non-toxic and biodegradable.

✔ Sold per 10 pcs



SOFT TOUCH - CLAY

The soft touch provides a user-friendly and frost-free surface that allows usage in **direct contact with the skin**. Filled with clay, a 100% natural product.

✔ Sold per 10 pcs



PROTECTION SLEEVE

100% polyester Protection Sleeve for Hot/Cold Packs. Machine washable. Available in 3 sizes (S | M | L).

✔ Sold per 10 pcs



TRI-SECTIONAL HOT/COLD PACK

The soft touch tri-sectional Hot/Cold Pack treats multiple zones at once (neck and shoulders).

✔ Sold individually & per 10 pcs



XXL HOT/COLD PACK

Ideal for pain relief on shoulders and back. This Hot/Cold Pack has a nylon cover.

✔ Sold individually



Dimension		Moves Hot/Cold Packs				Unit
		Classic (Gel)	Standard (Gel)	Soft Touch (Clay)	Protection Sleeve	
Small	15 x 25 cm	07-010102	07-010202	07-010302	07-020102	10 pcs
Medium	20 x 30 cm	07-010103	07-010203	07-010303	07-020103	10 pcs
Large	25 x 35 cm	07-010104	07-010204	07-010304	07-020104	10 pcs
XXL	33 x 47 cm	n/a	07-010206	n/a	n/a	1 pc
Tri-Sectional	40 x 20 cm	n/a	07-010211	07-010311	n/a	10 pcs
Tri-Sectional	40 x 20 cm	n/a	n/a	07-010312	n/a	1 pc

PearlPack MD 

Hot and cold therapy can be used to relieve pain and inflammations associated with muscle strain and sprain. This dual applicability makes them a strong alternative to ordinary heating pillows and ice packs. The small pearls absorb heat or cold, which they can retain for 20 minutes. During this time, these packs will relieve a part of your pain.

Not only do they look good, the products are very convenient in use. PearlPacks won't feel wet, nor drip after freezing or heating them, avoiding a mess. You can also use these in **direct contact with the skin**. All materials used are non-toxic and odourless.

Besides relieving pain from an injury or muscle strain, hot/cold packs are often used to reduce swelling after an operation. PearlPacks truly are multifunctional products.

PEARLPACK | SPORTS PACK & STRAP

The PearlPack Sports Pack comes with a handy velcro strap.



PEARLPACK | BACK WRAP

This large pack divided in 3 segments is equipped with a velcro strap. It fits perfectly around the user's waist for an optimal pain relief on the back. The pearls can be pushed from one segment to the other if one area of the back needs less or more thermal treatment.



PEARLPACK | EYE MASK

This mask adapts to the user's face and has a fabric strap. Hot treatment can be applied when the eyes feel dry or if there's an infection of the eyelid. Cold treatment will help when suffering from headaches, swollen eyes or sinusitis.



PEARLPACK | KNEE/ELBOW

This offers a solution for hot/cold therapy on the knee or elbow joints. The large opening ensures that your knee or elbow remains free, so you can continue to move freely, while the Pearl technology sends direct relief to the pain area. The flexible velcro strap keeps the pack firmly in place.





Reference code	Description	Dimension	Unit
07-O40102	Moves PearlPack Sports Pack+ strap	19 x 12,5 cm	1 pc
07-O40201	Moves PearlPack Back Wrap	43 x 17,5 cm	1 pc
07-O41101	Moves PearlPack Eye Mask	22,5 x 7,5 cm	1 pc
07-O40301	Moves PearlPack Knee/Elbow	37 x 25,6 cm	1 pc

Roll-on pack MD CE

Moves Roll-On Packs combine hot/cold treatment with practicality. The tubular shape and flexible material allow an easy roll-on application, even after being heated or frozen. The various sizes will fit perfectly over your finger, wrist, ankle or knee. This design ensures that the whole area will benefit from the treatment.

SPECIFICATIONS

-  Available in 5 sizes
-  Reusable, non-toxic and latex-free
-  Each Roll-On Pack includes a protective sleeve



Easy roll-on!

Reference code	Description	Inside diameter ∅	Circumference C	Uses	Unit
07-050101	Moves Roll-On Pack Finger	2,5 cm	One size fits all	Finger	1 pc
07-050102	Moves Roll-On Pack Small	10,0 cm	Fits up to 25 cm	Hand, wrist, arm, elbow	1 pc
07-050103	Moves Roll-On Pack Medium	12,5 cm	Fits 25 - 38 cm	Hand, wrist; arm, elbow, ankle	1 pc
07-050104	Moves Roll-On Pack Large	15,0 cm	Fits 38 - 53 cm	Elbow, ankle, foot, calf, knee	1 pc
07-050105	Moves Roll-On Pack Extra Large	17,5 cm	Fits 53 - 58 cm	Knee, thigh	1 pc

Instant heat pack

Have you ever needed a heat pack, but there was no kitchen or microwave in sight? Moves has the perfect solution for you! Your heat pack on-the-go. Simply flex the metal disk inside our Moves Instant Heat Pack and **within seconds** it will warm up to around a comfy **54°C**. Furthermore, it is **reusable** many times! Just boil the pack for 10 to 15 minutes and it will return to its original fluid state.

The Moves Instant Heat Pack comes in **two different sizes**:

1. POCKET SIZE PACK

Perfect for outdoor activities! Easy to use while camping, going to sporting events or whenever you go outside in colder weather. It is small, lightweight and fits neatly in your pocket.

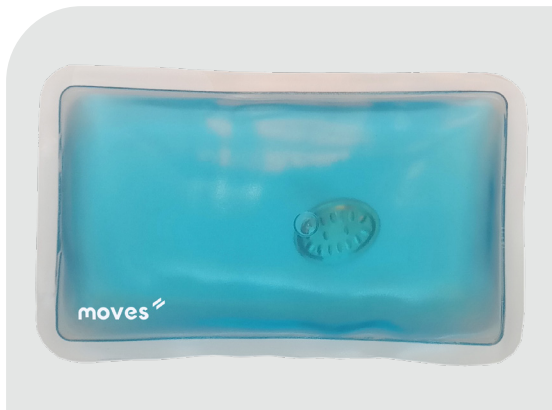

2. SHOULDER & NECK PACK

This 3-piece instant heat pack is designed to fit comfortably around your neck and shoulders. The instant heat pack loosens your muscles and relieves pressure and soreness.

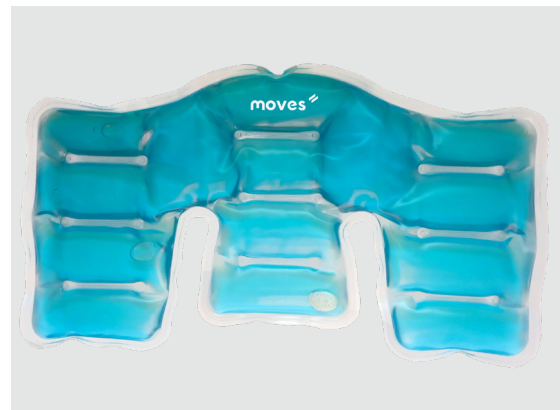

Reference code	Description	Dimension	Unit
O7-O6O1O1	Moves Instant Heat Pack Pocket Set of 3	12,7 x 7,6 cm	1 pc
O7-O6O111	Moves Instant Heat Pack Shoulder & Neck	41 x 25 cm	1 pc



O8 Evaluation



MicroFET™2 muscle test dynamometer MD CE

The wireless microFET™2 Digital Handheld Dynamometer is an accurate, portable Force Evaluation and Testing (FET) device. It is designed for taking objective, reliable and quantifiable **muscle testing measurements**. The microFET™2 aids in diagnosis, prognosis and treatment of neuromuscular disorders.

- Measurement range 0-136 kg (0-300 lb) force
- Easy-to-read LCD Displays shows peak force and elapsed time
- Selectable units of measure: pounds (lbs.), Newtons (N), or kilogram-force (kgf)
- Accuracy within 1% of the reading
- Two threshold settings for muscle testing: Low 0,4 to 136 kg (0,8 to 300 lb) in 0,05 kg (0,1 lb) increments and High threshold 1,4 to 136 kg (3,0 to 300 lb) in 0,05 kg (0,1 lb) increments
- Stores up to 30 tests
- Uses rechargeable lithium ion rechargeable battery
- Self-activating "sleep" mode after 3 minutes to extend battery life
- Available with US plug or with EU plug



Description	Reference code	Unit
MicroFET™2 MMT Handheld Dynamometer	I2-O381W	1 pc
MicroFET™2 MMT Handheld Dynamometer EU plug	I2-O381EU	1 pc

Fingertip pulse oximeter MD CE

A Pulse Oximeter is a very important and common device to check the patient's **blood-oxygen saturation (SpO₂) level** and **pulse rate**. As a compact, reliable and durable monitoring device, the Fingertip Pulse Oximeter greatly enhances patient care.

JUNIOR OXIMETER

Designed for kids from 3 - 12 years old.

- Rechargeable via USB-cable
- Dual colour OLED-screen displays SpO₂, PR, pulse bar and waveform
- 4-direction & 6-mode display for convenient reading
- Set-up alarm range of SpO₂ and pulse rate
- Menu-function setting (beep sounds, etc.)
- Lithium battery; automatically power off
- Gravity function, automatic rotating reading option



ADULT OXIMETER

Features:

- Dual colour OLED-screen displays SpO₂, PR, pulse bar and waveform
- SpO₂; measurement range between 70%-99% accuracy; ± 2% on the stage of 80%-99%
- PR; measurement range between 30BPM-240BPM accuracy; ± 1BPM or ±1% (the larger one)
- Low power indicator
- 6 display modes with adjustable brightness
- Automatically power off
- AAA alkaline batteries



Reference code	Description	Unit
O8-O7O2O1	Fingertip Pulse Oximeter Adult OLED 2 x AAA	1 pc
O8-O7O2O2	Fingertip Pulse Oximeter Junior 3-12y old OLED Rechargeable	1 pc

Blood pressure monitor



The blood pressure monitor is used for measuring **blood pressure** and **pulse rate**. It is suitable for people older than 12 years. It features:

- Large LCD display: 72 x 43,5 mm
- 2 users, 99 memories per user
- Irregular heart beating sign
- Indicating blood pressure level in 4 colours
- Average of last 3 records
- Low power detection
- Over pressure protection
- Automatic switch-off



Reference code	Description	Unit
O8-070501	Blood Pressure Monitor + Cuff	1 pc

Infrared thermometer



EAR & FOREHEAD THERMOMETER

The infrared thermometer is used for measuring body temperature by two-in-one functions: Ear and Forehead temperature. It is suitable for both medical and home use.

- Fast and easy temperature measurement by advanced infrared technology
- Range between 34,0°C-43,0°C accuracy; <35,0°C and >42,0°C = ± 0,3°C
- Memory mode
- Suitable for both infants and adults
- Easy operating and cleaning
- Automatic power off after 60 seconds
- 2 AAA alkaline batteries
- Tri-colour backlit:
 - ● <37,4°C
 - ● 37,4°C - 38,0°C
 - ● >38,0°C



SHOTGUN THERMOMETER

Measures your body temperature without direct contact with the skin. Can measure between 5-15 cm from the skin.

- Detailed 34 memories with time/data
- Response time: 1 second
- Effective distance: 5-15 cm
- User guidance by infrared beam
- Fever alarm



Reference code	Description	Unit
O8-070301	Infrared Thermometer Ear & Forehead auto-sensing 2 x AAA	1 pc
O8-070303	Infrared Thermometer Shotgun Forehead auto-sensing 2 x AAA	1 pc

Pedi-scoliometer



Scoliometers are inclinometers designed to **measure trunk asymmetry or Angle of Truncal Rotation (ATR)** used in scoliosis screening programmes. They are small, non-invasive devices which are placed over the spine while a person is in the forward bending position. The scoliometer reading indicates the degree of trunk asymmetry (rotation).



Reference code	Description	Unit
08-060102	Pedi-Scoliometer	1 pc

moves

Neurological reflex instruments



1. BUCK HAMMER

Two heads for cutaneous sensation evaluation. Comes with a needle and a brush.

2. BABINSKI HAMMER

Pointed bottom can be used as gross aesthesiometer.

3. TAYLOR HAMMER

Used to elicit responses during an examination.

4. DEJERINE HAMMER

Used for testing deep tendon reflexes in a diagnostic evaluation. Double-sided head composed of two rounded rubber surfaces for increased comfort.

5. TROEMNER HAMMER

Shaped like a two-headed mallet. The larger mallet is used to elicit tendon stretch reflexes, and the smaller mallet is used to elicit percussion myotonia.

6. WARTENBERG PINWHEEL

Used to elicit cutaneous sensory and pain perception responses.

Reference code	Description	Unit
08-050101	Moves Buck Hammer	1 pc
08-050102	Moves Babinski Hammer	1 pc
08-050103	Moves Taylor Hammer	1 pc
08-050104	Moves Dejerine Hammer	1 pc
08-050105	Moves Troemner Hammer	1 pc
08-050201	Moves Wartenberg Pinwheel	1 pc

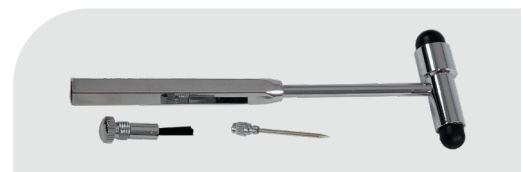

1. BUCK HAMMER



2. BABINSKI HAMMER

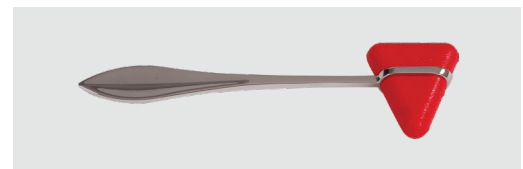

3. TAYLOR HAMMER



4. DEJERINE HAMMER

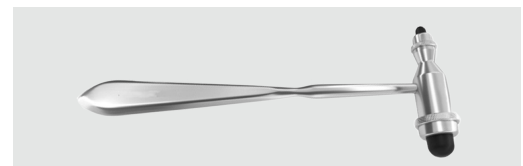

5. TROEMNER HAMMER



6. WARTENBERG PINWHEEL

[®]**SAEHAN**
Grip



About the Saehan® brand

Saehan® provides a wide range of measurement products. For example dynamometers, goniometers, body fat calipers and so on. All Saehan® products are CE and FDA approved. Discover the product assortment [here!](#)

Hydraulic hand dynamometer MD CE

The Hydraulic hand dynamometer gives accurate grip strength readings without the patient being able to “feel” the handle move. The adjustable handle has 5 positions to adapt to any hand size. The indicator remains at the patient’s maximum reading until it is reset. This product has a scale in both kilograms and pounds.

SPECIFICATIONS

- ↔ Range: 0 - 90 kg (200 lb)
- ✓ Comes in a quality hard carrying case
- ✓ Warranty: 2 years

Reference code	Description	Unit
O8-O1O1O1	Saehan Hydraulic Hand Dynamometer	1 pc



Hydraulic 3-piece hand evaluation kit MD CE

A portable hard carrying case containing all instruments necessary to evaluate the strength and range-of-motion of the hand and fingers.

SPECIFICATIONS

- ✓ Includes: hydraulic hand dynamometer
- ✓ Includes: hydraulic pinch gauge
- ✓ Includes: stainless steel finger goniometer 15 cm - 180° per 5°
- ✓ Warranty: 2 years

Reference code	Description	Unit
O8-O1O113	Saehan Hydraulic Hand Evaluation Kit 3 pieces	Set



Hydraulic 7-piece hand evaluation kit MD CE

This 7-piece Hand Evaluation Kit is a complete set of instruments to evaluate the strength and range-of-motion of the hand and fingers.

SPECIFICATIONS

- ✓ Includes: hydraulic hand dynamometer
- ✓ Includes: hydraulic pinch gauge
- ✓ Includes: stainless steel finger goniometer 15 cm - 180° per 5°
- ✓ Includes: 2-point discriminator with 3rd point
- ✓ Includes: Wartenberg pinwheel
- ✓ Includes: finger gauge
- ✓ Includes: functional finger motion gauge
- ✓ Warranty: 2 years

Reference code	Description	Unit
O8-O1O117	Saehan Hydraulic Hand Evaluation Kit 7 pieces	Set



Digital hand dynamometer with data transfer software - DHD-1 CE

Designed for reliable grip-force evaluations. This hand dynamometer has an easy-to-read LCD display. It features an electronic zero calibration system and up to 40 test data can be stored in memory. It is powered by a rechargeable Li-Ion polymer battery and data will not be lost when changing the battery. The Data Transfer Software can transfer the test results into .txt-files, which can be easily accessed using Notepad or MS-Word for editing and printing.

SPECIFICATIONS

- ↔ Range: 0 - 90 kg (200 lb)
- ✓ Comes in a quality hard carrying case
- ✓ Includes: digital hand dynamometer
- ✓ Includes: DTS-software
- ✓ Includes: USB cable
- ✓ Warranty: 1 year



Reference code	Description	Unit
08-010201	Saehan Digital Hand Dynamometer - DHD-1	1 pc

Digital hand dynamometer with G-STAR™ software - DHD-3 CE

The DHD-3 Digital Hand Dynamometer (SH1003) provides the same features as the DHD-1 when used as a stand-alone device, but adds automated Rapid Exchange Grip Testing. Using Auto Mode, up to 10 strength tests for each hand, as well as the time allowed to switch hands, can be configured to automate the testing procedure.

The Grip Strength Testing and Research (G-STAR™) is an easy to use software tool which automates grip strength testing and endurance testing in both clinical and research environments. All patient information and their test results are stored in an Access database.

SPECIFICATIONS

- ↔ Range: 0 - 90 kg (200 lb)
- ✓ Comes in a quality hard carrying case
- ✓ Minimum requirements: Windows XP and USB port
- ✓ Warranty: 1 year

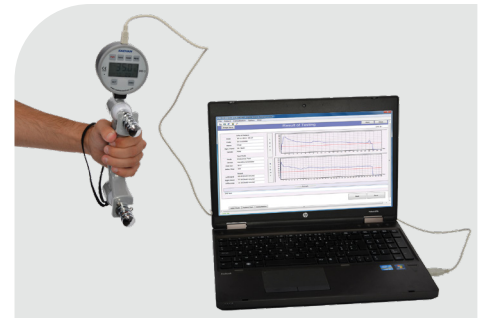

Reference code	Description	Unit
08-010202	Saehan Digital Hand Dynamometer - DHD-3 (including G-STAR™ software)	1 pc

Squeeze dynamometer MD CE

The Squeeze (bulb) Dynamometer is an inexpensive device to reliably measure hand and finger strength. The dynamometer has an indicator dial that remains at the maximum reading until reset. Unit is calibrated in pounds and kilograms.

SPECIFICATIONS

- ↔ Range: 0 - 70 kg (150 lb)
- ✓ Comes in a quality soft pouch case
- ✓ Warranty: 1 year



Reference code	Description	Unit
08-010301	Saehan Squeeze Dynamometer 70 kg	1 pc

Smedley hand dynamometer



The Smedley spring-type Dynamometer has been successfully used for many years to measure grip strength. The ergonomic handle is adjustable to fit all hand sizes. The unit is calibrated in kilograms and pounds.



SPECIFICATIONS

- ↔ Range: 0 - 100 kg (220 lb)
- ✓ Comes in a quality soft pouch case
- ✓ Warranty: 1 year

Reference code	Description	Unit
08-010401	Saehan Smedley Hand Dynamometer Ergonomic handle	1 pc

Back-leg-chest dynamometer



This Dynamometer measures the strength of your back, leg and chest. The base provides secure footing. The chain length is adjustable to accommodate for height differences or to vary the point of force application. It shows both pounds and kilograms. The pointer remains at maximum until it is reset.

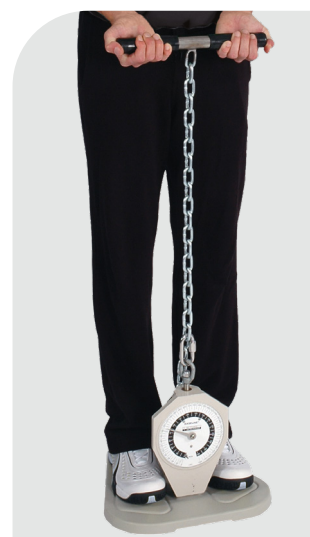

SPECIFICATIONS

- ↔ Range: 0 - 300 kg (660 lb)
- ✓ Comes fully assembled + 1,5 m chain
- ✓ Warranty: 1 year

Reference code	Description	Unit
08-010601	Saehan Back-Leg-Chest Dynamometer	1 pc

Pinch gauge



MECHANICAL PINCH GAUGE

Uses for hand-strength testing by measuring tip, key and palmar pinch force. Made of durable painted stainless steel. Mechanical properties will not degrade over time. It can serve as a diagnostic tool or for monitoring the progress of rehabilitation



SPECIFICATIONS

- ↔ Range: 0 - 20 kg (45 lb)
- ✓ Warranty: 1 year

Reference code	Description	Unit
08-020102	Saehan Mechanical Pinch Gauge	1 pc

HYDRAULIC PINCH GAUGE

Uses the improved hydraulic system of the hand dynamometer to assure convenience, product reliability, measurement accuracy and repeatability. This results in a more accurate test result for all pinch tests.



SPECIFICATIONS

- ↔ Range: 0 - 20 kg (45 lb)
- ✓ Warranty: 2 years

Reference code	Description	Unit
08-020101	Saehan Hydraulic Pinch Gauge	1 pc

Plastic goniometer MD CE

Clear plastic permits observation of joint's axis of motion, and its range of motion. The 360° head had three scales calibrated to be used with ISOM (International Standard Of Measurements, STFR) system.

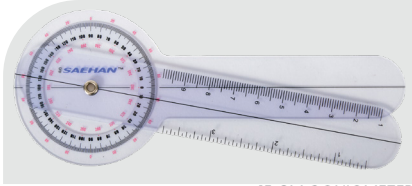

15 CM GONIOMETER



20 CM GONIOMETER

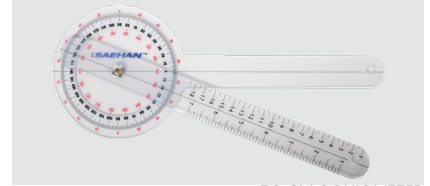

30 CM GONIOMETER

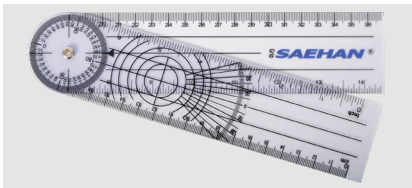

RULONG GONIOMETER



POCKET GONIOMETER

Reference code	Description	Length	Unit
08-030101	Saehan Plastic Goniometer 0° to 360° per 1°	15 cm	1 pc
08-030102	Saehan Plastic Goniometer 0° to 360° per 1°	20 cm	1 pc
08-030103	Saehan Plastic Goniometer 0° to 360° per 1°	30 cm	1 pc
08-030111	Saehan Rulong Goniometer 0° to 360° per 2°	18 cm	1 pc
08-030112	Saehan Pocket Goniometer 180° x 2 per 5°	15 cm	1 pc

Stainless steel goniometer MD CE

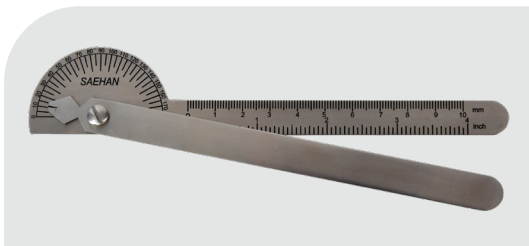

08-030201

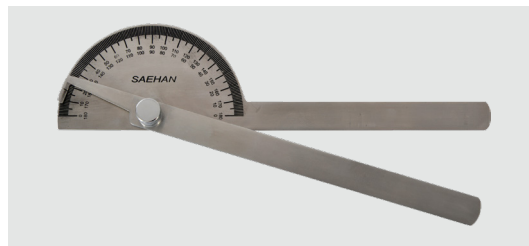

08-030202

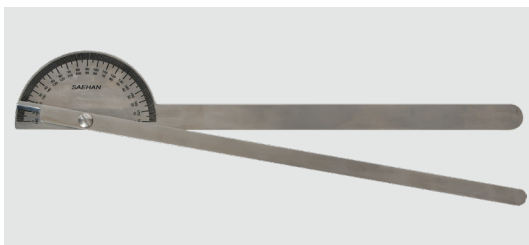

08-030203
ARM TENSION IS CONTROLLED BY THUMB KNOB

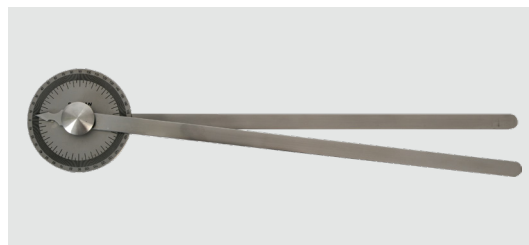

08-030204
EXTRA LONG ARMS FOR MEASURING ALL JOINTS

Reference code	Description	Length	Scale	Increments	Unit
08-030201	Saehan Stainless Steel Robinson Pocket Goniometer	15 cm	180°	5°	1 pc
08-030202	Saehan Stainless Steel Goniometer	20 cm	180° x 2	1°	1 pc
08-030203	Saehan Stainless Steel Goniometer	35 cm	180° x 2	1°	1 pc
08-030204	Saehan Stainless Steel Goniometer	35 cm	360°	1°	1 pc

Finger goniometer



Finger and Flexion/Hyper-Extension Goniometers measure range-of-motion of finger joints. The head has two opposing 180° scales marked in 5° increments. A linear scale in centimeters is located on the arm.



Reference code	Description	Unit
O8-O3O3O1	Saehan Stainless Steel Finger Goniometer 9 cm 180° per 5°	1 pc
O8-O3O3O2	Saehan Stainless Steel Finger Goniometer 15 cm 180° per 5°	1 pc

Goniometer kit



Excellent soft pouch case!

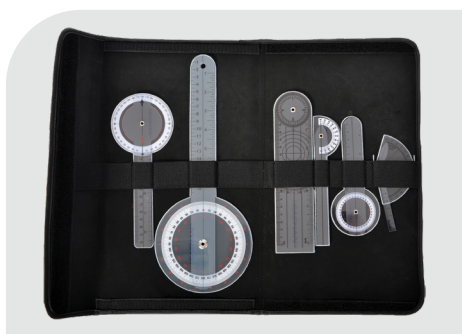

PLASTIC SET

- Plastic Goniometer 15 cm | 0° to 360° per 1°
- Plastic Goniometer 20 cm | 0° to 360° per 1°
- Plastic Goniometer 30 cm | 0° to 360° per 1°
- Rulong Goniometer 18 cm | 0° to 360° per 2°
- Plastic Goniometer 15 cm | 180° x 2
- Plastic Flexion-Hyperextension Goniometer



STAINLESS STEEL SET

- Robinson Pocket Goniometer 15 cm | 180°
- Stainless Steel Goniometer 18 cm | 180°
- Stainless Steel Goniometer 35 cm | 180° x 2
- Stainless Steel Goniometer 35 cm | 360°
- Stainless Steel Finger Goniometer 15 cm
- X-Ray Goniometer 20 cm | 180°

Reference code	Description	Unit
O8-O3O121	Saehan Goniometer Set Plastic 6 pcs	Set
O8-O3O211	Saehan Goniometer Set Stainless Steel 6 pcs	Set

Tuning fork

These aluminium Tuning Forks are developed to measure sensitivity to vibration which can be an indicator of nerve damage. It is also used for foot exams by diabetic people to check for signs of neuropathy.

Reference code	Description	Unit
O8-O5O3O1	Tuning Fork 128cps	1 pc
O8-O5O3O2	Tuning Fork 256cps	1 pc

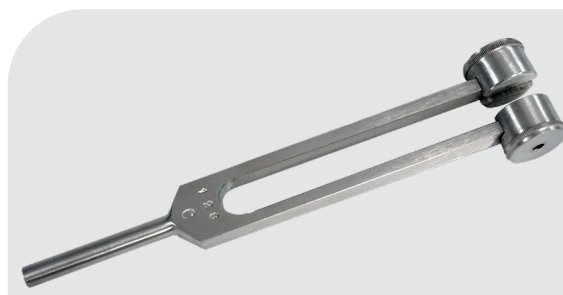

Fat caliper MD CE

Professional light-weight aluminium caliper. The measurement arms have floating tips to assure accurate and reproducible results. The 65 mm scale is large and easy to read. A corrective scale for sex and age is included in a multilingual manual

SPECIFICATIONS

- ✔ Comes in a quality soft pouch carrying case

Reference code	Description	Unit
08-040101	SaeHAN Skinfold Fat Caliper Aluminium - Green	1 pc





About the Baseline[®] brand

Baseline[®] measurement instruments have been used by orthopedists, therapists, FCE administrators and professors since the 1980s. Many of you who have received therapy after an injury have probably had your progress tested throughout your rehabilitation with a Baseline[®] measurement instrument.

The product line includes instruments to measure strength, range-of-motion (ROM), sensory perception, body measurements and more.

It's time to upgrade to digital with the BIMS™ digital 5-position grip and pinch dynamometers!

WHY SWITCH FROM A HYDRAULIC DYNAMOMETER TO DIGITAL?

- Force is measured using load-cell digital technology that gives more accurate, repeatable, and consistent measurements
- No hydraulic oil is used to measure force, eliminating the risk of oil leakage and decalibration
- Resetting of max results is digital; standard hydraulic reset knobs are prone to breaking
- LCD screen makes results easy to read
- Saves time by calculating mean, SD, COV, and other statistics on the device

WHY SHOULD I CHOOSE BIMS™ DIGITAL DYNAMOMETERS?

- Extended testing capacity (135 kg grip (300 lb) / 45 kg (100 lb)pinch) is designed for the strongest and weakest patients
- Measures force consistently with $\pm 1\%$ accuracy
- Color LCD display graphically shows results
- Numerous testing protocols for advanced testing
- 5-position hand grip accommodates different hand sizes and tests
- Results saved on device with memory for over 1000 patients



BIMS™ digital (Load-Cell) 5-position dynamometers

- Adjustable 5-position handle fits all size hands
- Accurate and repeatable grip and pinch strength measurements
- Grip dynamometers have an extended testing capacity that measures grip strength up to 135 kg (300 lbs)
- Pinch dynamometers measure pinch strength up to 45 kg (100 lbs)
- Purchase the dynamometer that meets your practice needs: **Functional, Clinic** or **Deluxe**
- Subject/Test information can be entered at time of test: for example, dominant hand, handle position, exertion/rest times, units (lb/kg)
- **1 year warranty**

TEST PROTOCOLS

- **Live Test:**
Shows real time and maximum value. Test result is not stored
- **Quick Test:**
Shows real time and maximum value. Maximum is stored
- **GST (General Strength Test):**
3 tests are performed at the same handle position. Peak, mean, SD, and COV are stored
- **RET (Rapid Exchange Test):**
6 tests (alternating hands) are performed at the same handle position
- **MMVE (Modified Maximum Voluntary Effort Test):**
5 tests are performed; 1 at each handle position
- **MVE (Maximum Voluntary Effort Test):**
15 tests are performed per hand; 3 at each handle position
- **Fatigue (Work Test):**
1 extended time test is performed. Results can be used to compare strength exerted (total work performed) over 2 or more user defined time periods



3-PIECE SETS INCLUDE GRIP DYNAMOMETER, PINCH DYNAMOMETER, PLASTIC FINGER GONIOMETER (12-1014), CARRY CASE, INSTRUCTIONS AND NORMS

FUNCTIONAL MODEL MD CE

This model does everything a standard hydraulic dynamometer can do with greater accuracy and repeatability. Use to view **live strength readings** with the **Max Force** test.

CLINIC MODEL MD CE

This model is ideal for clinic practitioners to perform timed tests which are **calculated and saved on the device**. It includes the **Max Force, Quick, and GST** tests.

DELUXE MODEL MD CE

This model expands upon the Clinic model and includes **more advanced timed tests** that are ideal for research applications, Workers' Compensation, FCE (Functional Capacity Evaluation) and day-to-day testing. It includes **Max Force, Quick, GST, RET, MMVE, MVE, and Fatigue** tests.

Reference code	Description	Unit
12-0072	Grip (135 kg / 300 lb)	1 pc
12-0082	Pinch (45 kg / 100 lb)	1 pc
12-0092	3-piece hand set	set

Reference code	Description	Unit
12-0070	Grip (135 kg / 300 lb)	1 pc
12-0080	Pinch (45 kg / 100 lb)	1 pc
12-0090	3-piece hand set	set

Reference code	Description	Unit
12-0071	Grip (135 kg / 300 lb)	1 pc
12-0081	Pinch (45 kg / 100 lb)	1 pc
12-0091	3-piece hand set	set

5-position hydraulic hand grip dynamometer MD CE

- This product gives accurate grip strength readings without the subject being able to “feel” the handle move
- Readings are repeatable
- Maximum reading remains until reset
- Readings in lb and kg
- CE certified; manufactured and serviced in the USA since 1978
- Recalibration available once/year based on warranty
- Five position handle and body contours assure results consistent with published Baseline[®] and Jamar[®] studies
- Internationally accepted design assures reliability, accuracy and repeatability
- Lightweight units include protective carry case, instructions for use and norms
- **90 kg (200 lb) capacity, 6,4 cm (2,5”) diameter dial head**

CHOOSE YOUR WARRANTY:



LITE[®] - 1 YEAR WARRANTY



STANDARD - 2 YEARS WARRANTY



HD[®] - 5 YEARS WARRANTY

Reference code	Description	Colour	Warranty	Unit
12-O241	LITE [®] Red finish	●	LITE [®] 1 year warranty	1 pc
12-O240	Standard Blue finish	●	Standard 2 year warranty	1 pc
12-O221	HD [®] Black finish	●	HD [®] 5 year warranty	1 pc

Pneumatic squeeze dynamometers MD CE

- The inexpensive way to measure grip and pinch strength
- Available with and without a maximum force indicator (reset) that remains at the maximum reading until reset
- Fluid-filled bulb; calibrated in PSI
- Smaller bulb 2,5 cm (1”) can be used for children and pinching
- Often used in pediatric rehabilitation



Reference code	Description	Unit
12-O291	30 PSI 1 year warranty	1 pc
12-O293	15 PSI 1 year warranty	1 pc

5 CM (2”) BULB WITH RESET

Reference code	Description	Unit
12-O297	3-bulb set 2 year warranty	set

3 BULB SET FOR GRIP AND PINCH MEASUREMENTS, INCLUDES 2,5 CM (1”), 3,8 CM (1,5”) AND 5 CM (2”) BULBS WITH RESET AND CASE. SIMILAR TO THE MARTIN VIGOROMETER

Smedley spring dynamometer

MD CE

- Adjustable handle to fit all hand sizes
- Readings in both kg and lb
- Includes carrying case
- Ideal cost-efficient solution to measure grip strength
- **2 years warranty**



Reference code	Description	Unit
12-O281	Adult (100 kg / 220 lb)	1 pc

Electronic Smedley dynamometer

MD CE

- 5-preset grip sizes
- 90 kg (200 lb) capacity
- Saves/stores results for up to 19 users for fast retrieval
- **2 years warranty**



Reference code	Description	Unit
12-O286	Digital Smedley (90 kg / 200 lb)	1 pc



Mechanical pinch gauge

MD CE

- Measure tip, key, and palmar pinch strength in kg and lb
- Results are consistent with published Mathiowetz studies
- Indicator remains at the maximum reading until reset
- Includes protective case
- **2 years warranty**



Reference code	Description	Colour	Purpose	Unit
12-O200	13,6 kg (30 lb), blue	●	For orthopedic and sports medicine	1 pc
12-O201	27 kg (60 lb), red	●	For orthopedic and sports medicine	1 pc
12-O203	4,5 kg (10 lb), silver	●	For weak or damaged hands	1 pc
12-O202	0,9 kg (2 lb), gold	●	For weak or damaged hands	1 pc



Hydraulic pinch gauge MD CE

- Measure tip, key, and palmar pinch strength in kg and lb
- Includes protective case
- The hydraulic system guarantees a more accurate test result for all pinch tests

CHOOSE YOUR WARRANTY:



Reference code	Description	Colour	Warranty	Unit
12-O226	23 kg (50 lb) LITE®	●	LITE® 1 year warranty	1 pc
12-O235	23 kg (50 lb) Standard	●	Standard 2 year warranty	1 pc
12-O222	23 kg (50 lb) HD®	●	HD® 5 year warranty	1 pc

5-position hydraulic pinch gauge MD CE

Unlike standard pinch gauges, the 5-position pinch gauge has an easy-to-adjust paddle that accommodates to any hand size. This assures **accurate and repeatable pinch measurements**. 5 pinch positions permit strength test protocols (MVE and MMVE) to be used with tip, palmar and key tests.

- Users can't see results during testing
- 23 kg (50 lb) capacity
- Reads in both kg and lb
- **2 years warranty**

Reference code	Description	Unit
12-O480	5-position hydraulic pinch gauge	1 pc



Electronic pinch gauge MD CE

- LCD display shows grip force in kg or lb
- Perform tip, key, and palmar tests
- Stores 99 readings
- 27 kg (60 lb) capacity
- 3V battery included
- **2 years warranty**

Reference code	Description	Unit
12-O475	Baseline® electronic pinch gauge	1 pc



7-piece hand sets



- Protective carrying case stores instruments
- 3 different sets based on the **hydraulic hand grip dynamometer of your choice**.



1. LITE[®] SET (12-O102)

This set contains the following components:

- **Hydraulic hand grip dynamometer LiTE[®] | Red finish | 1 year warranty (12-O241)**
- Mechanical pinch gauge | 13,6 kg (30 lb) | Blue finish (12-O200)
- Stainless steel goniometer
- 2-point discriminator with 3rd point
- Wartenberg pinwheel
- Finger circumference gauge
- Functional finger motion gauge

Reference code	Description: Grip / Pinch	Warranty	Unit
12-O102	90 kg (200 lb) (12-O241) / 13 kg (30 lb) (12-O200) LITE [®]	LiTE [®] 1 year warranty	Set



SET 1

2. STANDARD SET (12-O100)

This set contains the following components:

- **Hydraulic hand grip dynamometer Standard | Blue finish | 2 year warranty (12-O240)**
- Mechanical pinch gauge | 13,6 kg (30 lb) | Blue finish (12-O200)
- Stainless steel goniometer
- 2-point discriminator with 3rd point
- Wartenberg pinwheel
- Finger circumference gauge
- Functional finger motion gauge

Reference code	Description: Grip / Pinch	Warranty	Unit
12-O100	90 kg (200 lb) (12-O240) / 13 kg (30 lb) (12-O200) Standard	Standard 2 year warranty	Set



SET 2

3. HD[®] SET (12-O117)

This set contains the following components:

- **Hydraulic hand grip dynamometer HD[®] | Black finish | 5 year warranty (12-O221)**
- Mechanical pinch gauge | 13,6 kg (30 lb) | Blue finish (12-O200)
- Stainless steel goniometer
- 2-point discriminator with 3rd point
- Wartenberg pinwheel
- Finger circumference gauge
- Functional finger motion gauge

Reference code	Description: Grip / Pinch	Warranty	Unit
12-O117	90 kg (200 lb) (12-O221) / 13 kg (30 lb) (12-O200) HD [®]	HD [®] 5 year warranty	Set



SET 3

3-piece hand sets



- Protective carrying case stores instruments
- 3 different sets based on the **warranty of your choice**.



1. LITE[®] SET (12-O101)

This set contains the following components:

- **Hydraulic hand grip dynamometer LiTE[®] | Red finish | 1 year warranty (12-O241)**
- Hydraulic pinch gauge | 23 kg (50 lb) | LiTE[®] | Red finish | 1 year warranty (12-O226)
- 15 cm (6") stainless steel goniometer

Reference code	Description Grip / Pinch	Warranty	Unit
12-O101	90 kg (200 lb) (12-O241) / 23 kg (50 lb) (12-O226) LiTE [®]	LiTE [®] 1 year warranty	Set



SET 1

2. STANDARD SET (12-O103)

This set contains the following components:

- **Hydraulic hand grip dynamometer Standard | Blue finish | 2 year warranty (12-O240)**
- Hydraulic pinch gauge | 23 kg (50 lb) | Standard | Blue finish | 2 year warranty (12-O235)
- 15 cm (6") stainless steel goniometer

Reference code	Description Grip / Pinch	Warranty	Unit
12-O103	90 kg (200 lb) (12-O240) / 23 kg (50 lb) (12-O235) Standard	Standard 2 year warranty	Set



SET 2

3. HD[®] SET (12-O116)

This set contains the following components:

- **Hydraulic hand grip dynamometer HD[®] | Black finish | 5 year warranty (12-O221)**
- Hydraulic pinch gauge | 23 kg (50 lb) | HD[®] | Black finish | 5 year warranty (12-O222)
- 15 cm (6") stainless steel goniometer

Reference code	Description Grip / Pinch	Warranty	Unit
12-O116	90 kg (200 lb) (12-O221) / 23 kg (50 lb) (12-O222) HD [®]	HD [®] 5 year warranty	Set



SET 3

Monitor® exercise feedback device MD CE

The Baseline® Monitor® exercise feedback device accurately measures and monitors body movements during exercise, making it ideal for physical therapists, athletic trainers, and home use. The device features a combination gauge/inflation bulb connected to a pressure 3-part chamber, which detects real-time air pressure changes to assist with positional adjustments. It is specifically designed for core stabilization training, which improves lumbar spine health by stabilizing the lower back through specific muscle engagement. It helps prevent and treat lower back and neck pain with slow, monitored movements. Users receive real-time feedback on their progress, making exercises more effective.

- dimensions: 8" x 4" x 4"
- weight: 1.16 lbs
- measurement: from 0 to 4 PSI (0-200 mmHg) analog pressure
- accuracy: +0.06 PSI (+3 mmHg).
- kit includes: pressure gauge, inflation tube, pressure chamber, and instructions



Reference code	Description	Unit
13-1520	Baseline Monitor Exercise Feedback Device	1 pc

Push-pull dynamometer MD CE

- Lightweight, small, and portable; easy to grasp with or without handles
- Use for muscle strength management, job task analysis, or functional capacity evaluation
- Comes with 3 push pads and 2 pull hooks
- **2 years warranty**

Reference code	Description	Unit
12-O393	Hydraulic - analog (45 kg / 100 lb)	1 pc
12-O389	Dual Grip for push-pull dynamometer	1 pc



HYDRAULIC

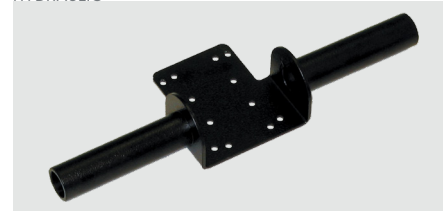

DUAL GRIP

Back-leg-chest dynamometer MD CE

- Measures strength of back, leg, and chest muscles
- Base provides secure footing
- Adjustable chain to accommodate for height differences or to vary the point of force application
- Comes fully assembled with 1.5 m (5-foot) chain
- Oversize base 60 x 60 cm (24" x 24"); regular base 45 x 45 cm (18" x 18")
- Pointer remains at maximum until reset
- Reads kg and lb



Reference code	Description	Unit
12-O400	Adult with standard base, 300 kg (660 lb)	1 pc

Finger (digit) goniometers MD CE

- Measures 110° flexion through 40° hyperextension in 2° increments on plastic model (5° increments on metal model)
- Arm has 10 cm (4") linear scale
- Use one finger to move the measurement head through flexion, extension, and hyperextension
- **Readings can be taken using only one hand**, freeing the therapist's other hand to stabilize the patient during measurement or to record the measurement. Standard finger goniometers require two hands to take a finger ROM measurement



Reference code	Description	Unit
12-1014	Plastic digit goniometer	1 pc
12-1016	Stainless steel digit goniometer	1 pc

Plastic finger goniometer MD CE

- Scale reads in 1 degree increments; linear scale reads in cm and inches
- Measures flexion to hyper-extension

Reference code	Description	Unit
12-1012 (old reference: O8-O30601)	Flexion to Hyper-Extension Finger Goniometer	1 pc

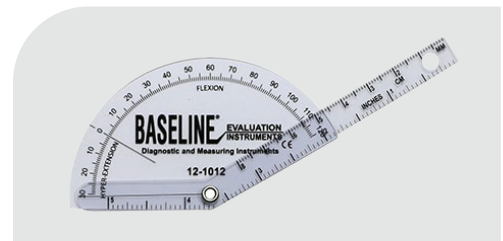

180° 20 cm goniometer MD CE

- Two opposing scales marked in 1° increments
- Tension between the arms is controlled by the thumb knob
- Stainless steel

Reference code	Description	Unit
12-1040	20 cm (8"), 180°	1 pc

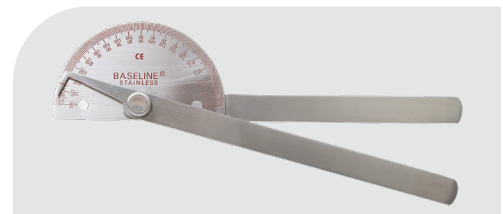

180° 35 cm goniometer MD CE

- Two opposing scales marked in 1° increments
- Extra-long arms for measuring all joints
- Stainless steel

Reference code	Description	Unit
12-1041	35 cm (14"), 180°	1 pc



360° 35 cm goniometer MD CE

- Two opposing 180° scales and one 360° scale, all marked in 1° increments
- Arm tension is controlled by the thumb knob
- Stainless steel

Reference code	Description	Unit
12-1050	35 cm (14"), 360°	1 pc

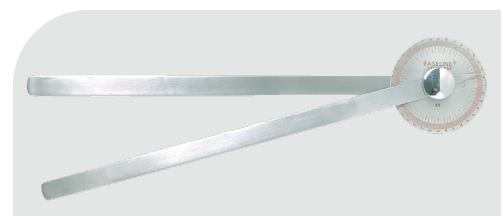

180° finger (small joint) goniometer MD CE

- Stainless steel goniometer measures ROM of finger joints (metacarpophalangeal and interphalangeal) and other small joints including toes
- Head has opposing 150° scales in 5° increments
- Linear scale in cm and inches



SMALL FINGER

Reference code	Description	Unit
12-1010	Standard finger, 15 cm (6")	1 pc
12-1015	Small finger, 9 cm (3,5")	1 pc



STANDARD FINGER

6-piece goniometer set MD CE

- 6 goniometers in a padded carrying case
- 15 cm (6") 180° Robinson pocket
- 35 cm (14") 180° stainless steel
- 35 cm (14") 360° stainless steel
- 15 cm (6") stainless steel finger
- 20 cm (8") 180° x-ray
- 20 cm (8") 180° stainless steel



Reference code	Description	Unit
12-1043	Goniometer set	Set

XTender[®] extendable goniometer MD CE

- Arms extend to measure large and small joints
- Extendable arms allow the goniometer to lie over anatomical bony landmarks
- Head is the same as a traditional goniometer for easy use
- Metal legs extend from 25 cm (10") to 90 cm (36")

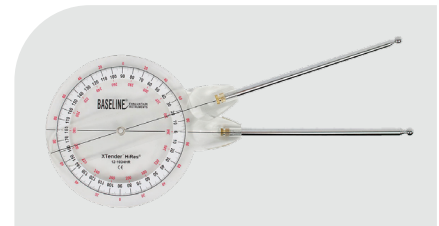

ARMS COLLAPSED

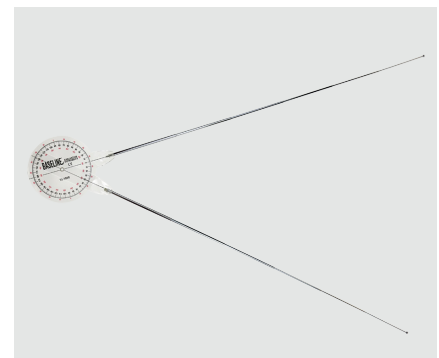

ARMS EXTENDED

Reference code	Description	Unit
12-1034HR	XTender [®] extendable goniometer	1 pc

Lafayette goniometer MD CE

A goniometer is a useful tool to assess the range of motion of the joints. The Lafayette Goniometer has extendable arms, which allows it to lie over anatomical bony landmarks. This results in the ability to measure all joints, no matter how big or small. The goniometer also has a magnifying lens to read the double 180 degree scale.



Reference code	Description	Unit
12-1035 (old reference: O8-O30701)	Lafayette Gollehan Extendable Goniometer with Magnifying Lens 24 x 26 cm 180°	1 pc

Plastic goniometers MD CE

- Scale reads in 1 degree increments; linear scale reads in cm and inches
- Hi-Res[®] option has white background behind the gradations and numbers for enhanced readability
- Take readings from absolute vertical or horizontal with the Absolute+Axis[®] goniometer

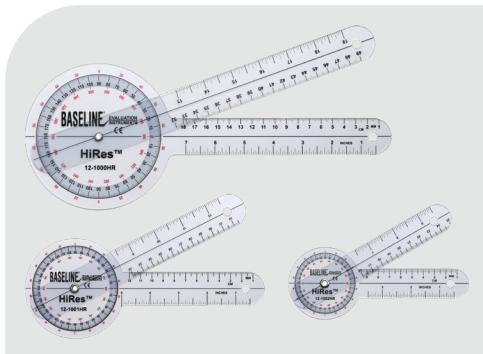

CLINIC - 15 CM PLASTIC ISOM (BOTTOM RIGHT)
CLINIC - 20 CM PLASTIC ISOM (BOTTOM LEFT)
CLINIC - 30 CM PLASTIC ISOM (TOP)

Reference code	Description	Unit
Clinic - plastic ISOM		
12-1000HR	30 cm (12") ISOM Hi-Res [®] 360°	1 pc
12-1001HR	20 cm (8") ISOM Hi-Res [®] 360°	1 pc
12-1002HR	15 cm (6") ISOM Hi-Res [®] 360°	1 pc
Patient - plastic pocket		
12-1005HR	15 cm (6") pocket Hi-Res [®] 180°	1 pc
Plastic sets		
12-1028HR	Hi-Res [®] set - 6 pieces	Set
Absolute axis - plastic		
12-1025 (old reference: O8-O30401)	30 cm (12") Absolute+Axis [®]	1 pc
12-1025HR	30 cm (12") Absolute+Axis [®] Hi-Res [®]	1 pc
12-1026	AA attachment only	1 pc



PATIENT - 15 CM POCKET

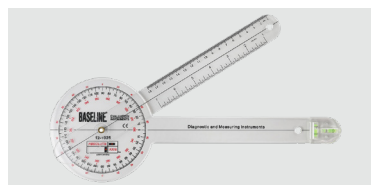

30 CM ISOM ABSOLUTE+AXIS[®] (12-1025)

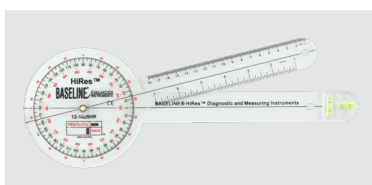

30 CM ISOM ABSOLUTE+AXIS[®] HI-RES[®] (INTEGRATED INTO GONIOMETER) (12-1025HR)

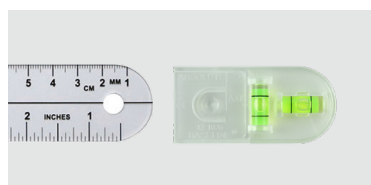

ABSOLUTE+AXIS[®] ATTACHMENT SLIDES ONTO ANY 30 CM GONIOMETER

Digital goniometer MD CE

- Digital plastic goniometer. Reads 0-360° on a LCD screen; 25 cm linear scale

Reference code	Description	Unit
12-1049	25 cm (10") plastic 360°	1 pc

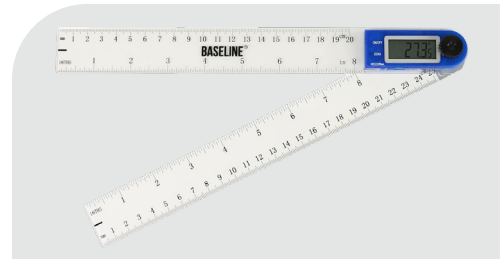

Touch-Test® 2-point discriminator MD CE

- Tests static, **moving** 2-point discrimination
- Consists of two sturdy, rotating, plastic discs that are joined together
- Includes instructions and carrying case

Reference code	Description	Unit
12-1495	Touch Test® 2-point	1 pc

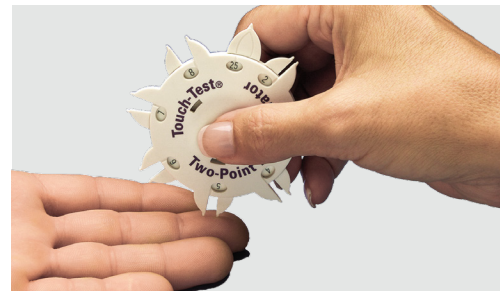

Discrim-A-Gon® 2-point discriminator MD CE

- Easy-to-use, lightweight plastic wheel is the perfect sensory evaluation tool to test static and dynamic 1 and 2-point discrimination
- 2 separate 2-point discrimination octagons (D1 and D2) come in a set
- Each octagon measures a different range of 8 labeled, **fixed**, 2-point intervals ranging from 1 to 25mm

Reference code	Description	Unit
12-1492	Discrim-A-Gon® set (2 discs)	Set



D1

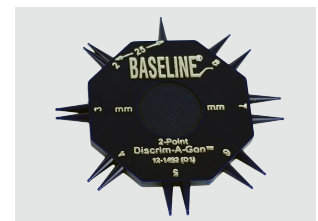

D2

2-point discriminators MD CE

- Evaluate cutaneous sensitivity and touch threshold
- Third point permits alternating between single and double point stimulation without changing setting
- Plastic points minimize influence of temperature
- Measures up to 4 cm

Reference code	Description	Unit
12-1480	2-point discriminator	1 pc
12-1481	with third point	1 pc

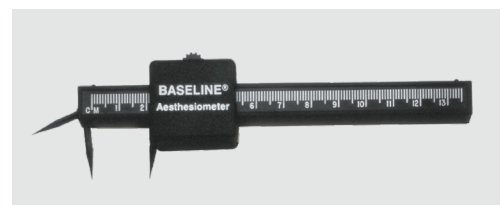

Sit 'n Reach[®] box test MD CE

- Perform sit 'n reach[®] flexibility tests
- Measurements include: fitness program, Cooper Institute/YMCA, SHAPE America (formally known as AAHPERD)
- Scales printed in cm and inches
- Sturdy metal construction with a built-in foot plate and a maximum stretch indicator that remains until reset

Reference code	Description	Unit
12-1085	Standard Sit 'n Reach [®] box test	1 pc



Finger flexion gauge MD CE

- Clear plastic gauge simplifies and speeds measurement of composite finger flexion and finger-thumb opposition
- Scale measures up to 10 cm

Reference code	Description	Unit
12-1060	Finger flexion gauge	1 pc



Gulick measurement tape MD CE

- Spring exerts constant force on tape for accurate and repeatable results
- Push-button retractor
- Reads in cm and inches

Reference code	Description	Unit
12-1201	150 cm tape	1 pc
12-1203	180 cm tape	1 pc



Finger circumference gauge MD CE

- Wrap webbing around finger or digit and read circumference in both cm and inches

Reference code	Description	Unit
12-1222	Gauge (in/cm)	1 pc



Circumference tape MD CE

- Measure the circumference of a body part in both cm and inches

Reference code	Description	Unit
12-1205	Tape	1 pc

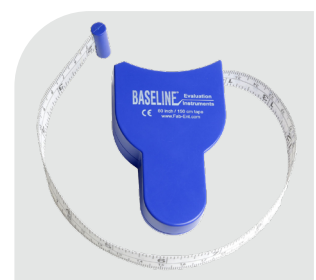

Clinical monofilament sensory evaluators



The Baseline Monofilament evaluator is used to measure cutaneous sensory perception threshold. It measures sensitivity, nerve damage or impairment, and changes in neurological status. Each monofilament represents a unique amount of force which is marked by force and size.

1. TACTILE™ MONOFILAMENTS

These monofilaments have a fitted protective case that enables safe storage and transport.

Reference code	Description
12-1660 (old reference: O8-O5O421)	2-piece set, normal 2,83 - 3,61
12-1668 (old reference: O8-O5O425)	2-piece set, protective sensation 4,56 - 5,07



2. FOLD-UP™ MONOFILAMENTS

These monofilaments feature an easy to fold nylon filament for protection as well as easy storage and portability. Sets are shipped and stored in a soft-shell protective carrying case.

Reference code	Description
12-1740	5-piece set, hand 2,83 - 3,61 - 4,31 - 4,56 - 6,65
12-1741	6-piece set, foot 2,83 - 3,61 - 4,31 - 4,56 - 5,07 - 6,65
12-1743	20-piece set, complete

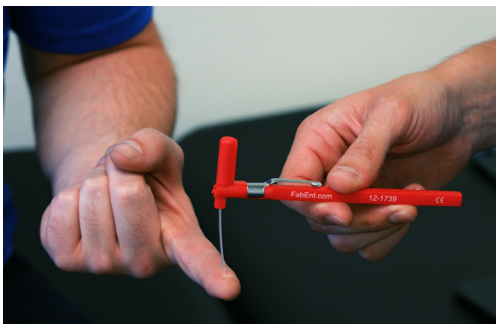

20-PIECE SET:

COLOUR	USE	QUANTITY	SIZE	FORCE
●	Normal	1 pc	1,65	(0,008 gm)
●		1 pc	2,36	(0,02 gm)
●		1 pc	2,44	(0,04 gm)
●		1 pc	2,83	(0,07 gm)
●	Diminished light touch	1 pc	3,22	(0,16 gm)
●		1 pc	3,61	(0,4 gm)
●	Diminished protective sensation	1 pc	3,84	(0,6 gm)
●		1 pc	4,08	(1,0 gm)
●		1 pc	4,17	(1,4 gm)
●		1 pc	4,31	(2,0 gm)
●	Loss of protective sensation	1 pc	4,56	(4,0 gm)
●		1 pc	4,74	(6,0 gm)
●		1 pc	4,93	(8,0 gm)
●		1 pc	5,07	(10,0 gm)
●		1 pc	5,18	(15,0 gm)
●		1 pc	5,46	(26,0 gm)
●		1 pc	5,88	(60,0 gm)
●		1 pc	6,10	(100,0 gm)
●		1 pc	6,45	(180,0 gm)
●		1 pc	6,65	(300,0 gm)

3. DISPOSABLE MONOFILAMENTS

These are individual 5,07 / 10 gm monofilaments that are disposable, making them ideal for clinics and other multi-patient environments

Reference code	Description	Unit
12-1670	Baseline Tactile Monofilament LEAP Program Disposable	1 pc
12-1670-20	Baseline Tactile Monofilament LEAP Program Disposable	20 pcs
12-1670-40	Baseline Tactile Monofilament LEAP Program Disposable	40 pcs

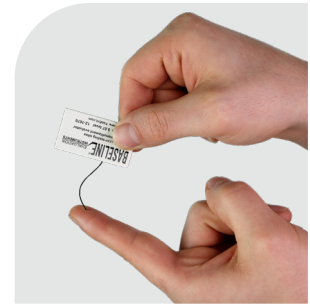

4. MULTI-FILAMENT PEN



The multi-filament pen offers a non-invasive evaluation of the diminished protective sensation. The pen contains 4 nylon monofilaments, each representing a unique amount of force which is marked by colour and size. Simply slide down the lever of the desired monofilament and use as intended. This pen provides a useful set of monofilaments in a fun, compact, and protected form.

COLOUR	USE	SIZE	FORCE
●	Normal	2,83	(0,07 gm)
●	Diminished light touch	3,61	(0,4 gm)
●	Diminished protective sensation	4,56	(4 gm)
●	Loss of protective sensation	5,07	(10 gm)



Reference code	Description	Unit
12-1370	Baseline Multi-Filament Pen	1 pc

Tuning forks



- Use to evaluate audio and vibratory sensation

Reference code	Description	Unit
Set of six pieces with case		
12-1460	128, 256, 512, 1024, 2048, 4096 cps	6 pcs
Weighted tuning forks		
12-1466	128 cps weighted	1 pc
12-1467	256 cps weighted	1 pc
Unweighted tuning forks		
12-1468	512 cps	1 pc



Pinwheel



- Test for nerve damage or nerve dysfunction with the **Baseline® Clearwheel®**
- Used by orthopedists, neurologists, chiropractors and other healthcare practitioners to test a patient's ability to feel sharp contact with the skin
- Consists of a rotating pinwheel attached to a handle

Reference code	Description	Unit
12-1446	Non-sterile Clearwheel®	1 pc

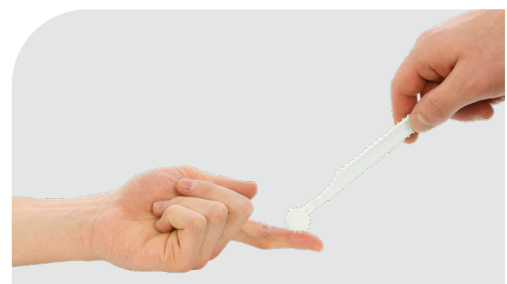

Bubble[®] inclinometer MD CE

- Place the inclinometer near the joint to measure, turn dial until scale reads 0, take joint through its range, read range from dial
- Some measurements need the use of 2 inclinometers
- Standards codified in "AMA Guide to the Evaluation of Permanent Impairment, third edition"

Reference code	Description	Unit
12-1056	Bubble [®] inclinometer	1 pc



AcuAngle[®] inclinometers MD CE

- Place inclinometer near joint to be measured; turn dial to 0; take joint through its range; read ROM from dial
- **AcuAngle[®] Inclinometer** has adjustable feet along scale (side-to-side) that adapts to body contours; Pointer is damped by fluid to assure accurate ROM measurements
- **AcuAngle[®] Wrist Inclinometer** measures ROM of the wrist along all axes; distance between feet is adjustable

Reference code	Description	Unit
12-1149	AcuAngle [®] inclinometer	1 pc
12-0502	AcuAngle [®] wrist inclinometer	1 pc



ACUANGLE[®] WRIST INCLINOMETER



ACUANGLE[®] INCLINOMETER

Digital inclinometer MD CE

- Place inclinometer near the joint to be measured; press "zero" button; move joint through its range; press the "hold" button
- Read ROM directly after the joint has been taken through its range



Reference code	Description	Unit
12-1057	Digital inclinometer	1 pc

Scoliometer MD CE

- Measure the degree of rotation of a deformity on the back
- Small, non-invasive
- 19 cm (7,5") L x 9 cm (3,5") W
- Includes storage pouch

Reference code	Description	Unit
12-1099	Scoliometer	1 pc



Economy skinfold caliper MD CE

- **Plastic** skinfold caliper is the inexpensive choice for skinfold analysis
- Spring-loaded arm assures reproducible results
- Floating tips assure accurate and reproducible results
- 50 mm scale
- With booklet and tables



WITH FLOATING MEASUREMENT TIPS

Reference code	Description	Unit
12-1112	Economy skinfold caliper	1 pc

Skinfold calipers MD CE

- 2-sided lightweight **aluminum** caliper is easy to use and read for left- or right-handed people; includes calibration block
- Floating tips to assure accurate and reproducible results
- Large, easy-to-read 70 mm scale
- Includes protective carrying case
- Calibration block verifies at 5-50 mm
- Easily fits into your pocket



DOUBLE SIDED CALIPER - FRONT



DOUBLE SIDED CALIPER - BACK



CALIBRATION BLOCK



SINGLE SIDED CALIPER

Reference code	Description	Unit
12-1130	Deluxe (dual sided) with calibration block	1 pc + block
12-1110	Skinfold caliper (single sided) without calibration block	1 pc

BMI Body Fat Scale MD CE

- Made with tempered glass
- Measures weight, body fat and water %
- Measurements range from 4% to 60% body fat; 27.5% to 66% hydration; 20% to 56% muscle; 2% to 20% bone
- Percentages are measured in 0.1% increments
- 12-person memory
- 32 cm (12.5") L x 31 cm (12.25") W x 5 cm (2") H
- Weight capacity is 400 lb / 180 kg
- Requires 2 AAA batteries (included)



Reference code	Description	Unit
12-1190 (old reference: 08-070101)	BMI Body Fat Scale	1 pc

15 ADL aids for daily living

NEW



StayPut® MD CE

Slips and falls are common accidents leading to anything from minor bruises to serious injuries like fractures. However, these incidents can be reduced with StayPut®, a non-slip material that provides better stability and grip across various settings.

This versatile, non-slip material grips on both sides, which makes it ideal for creating safer environments at home, in workplaces, and healthcare facilities. It prevents rolling, slipping, and sliding, making it perfect for keeping objects steady and improving safety for individuals. StayPut® features superior grip strength, holding items firmly on flat or uneven surfaces, including those subject to tipping or movement. Its rubberized, durable texture enhances stability for individuals walking or standing on it. The material is non-toxic, meeting CA Prop 65 and Reach safety standards.

Applications:

- Line drawers, shelves, trays, or cupboards to prevent items from sliding
- Use under cushions, chairs, or mats to enhance grip and stability
- Improve grip on canes, walkers, utensils, and cutlery
- Holds items firm on non-flat surfaces or surfaces subject to tipping or motion



SPECIFICATIONS

Available in 4 sizes:



- 20 cm x 180 cm
- 20 cm x 925 cm
- 40 cm x 180 cm
- 40 cm x 925 cm



Material: latex-free and non-toxic



- Durable & reusable: clean with soap and water (microwavable, and dishwasher-safe)
- Flexible material can be cut to any size or shape
- Easy to apply, quick to remove



925 cm rolls come in a convenient dispenser box

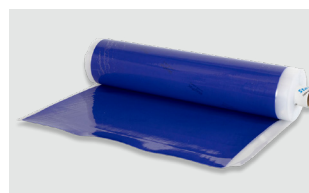
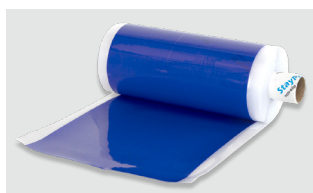
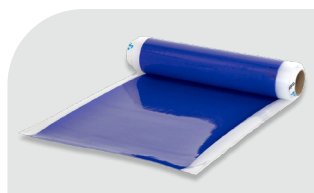

20 CM X 180 CM

20 CM X 925 CM

40 CM X 180 CM

40 CM X 925 CM

Colour	Reference code	Description	Unit
●	15-O1O1O1	StayPut non-slip material 20 cm x 180 cm	1 pc
	15-O1O1O2	StayPut non-slip material 20 cm x 925 cm	1 pc
	15-O1O2O1	StayPut non-slip material 40 cm x 180 cm	1 pc
	15-O1O2O2	StayPut non-slip material 40 cm x 925 cm	1 pc



UpCup

The UpCup is an **innovative drinking cup** specifically designed for the elderly, individuals with disabilities, those with strength, coordination, or swallowing difficulties, and people who struggle with independent drinking. The stable base and comfortable handles help those with difficulty gripping or swallowing drinks more easily and confidently. That way, the UpCup helps users regain their independence while enjoying their favorite beverages.

The UpCup addresses common issues found in many existing drinking cups, such as difficulty gripping, excessive tilting, hard-to-clean surfaces, unstable bases, poor insulation, and frequent spills or leaks. In addition to being functional, the UpCup is stylish, durable, and dishwasher-safe, offering both practicality and ease of cleaning.

Benefits:

- Ergonomic, wide, non-slip grip with side ribs for greater tactile experience
- Supportive handles for a varied drinking experience
- Double-walled design, useful when holding hot drinks
- Tulip-shaped drinking rim with a large opening ensures spill-free drinking
- Conical interior enhances aftertaste and reduces the need to tilt when drinking
- Easy stirring for thickening agents
- Wide base ensures stability
- Compact design

Developed in collaboration with occupational therapists, speech therapists, rehabilitation specialists, and top hospitals and nursing homes, the UpCup has been thoroughly tested to optimize grip, usability, and ergonomics.



SPECIFICATIONS

- ↔ Measurements (D x W x H): 100 x 76 x 145 mm
- 📖 Weight: 124 g
- 🍵 Capacity: 200 ml, measurement markings per 50 ml
- 📏 Drinking rim: 84 mm
Distance grip: 58 mm
- 🔍 Material: Transparent TRITAN



Reference code	Description	Unit	📄
15-050101	UpCup	1 pc	

Beat It!

The Beat It is an innovative tool, specially designed for seniors, people with disabilities, impairments, or permanent injuries. It is a **multifunctional clamp** that allows you to easily secure various items such as cups, cans, jars, bottles, and drinking containers of all kinds. No more instability or items tipping over!

How does this device work?



The Beat It is a handy clamp with a **sliding mechanism** that allows you to **secure anything that fits between it**. Place the item you want to secure between the two triangular elements. Slide the lever towards the object and lock it by pushing it down. This simple mechanism provides users with greater autonomy and ease in their everyday activities. The sturdy design and straightforward functionality make it a practical and effective aid.

This product comes with a **handy table clamp** that can be inserted on the side, securing your Beat It to the table.

SPECIFICATIONS

↔ Measurements (L x W x H): 22 x 11,5 x 7 cm
*WITHOUT TABLE CLAMP

🛒 Weight: 247 g
*WITHOUT TABLE CLAMP

Reference code	Description	Unit	
15-050102	Beat It	1 pc	

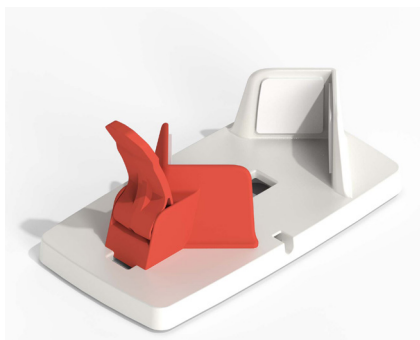
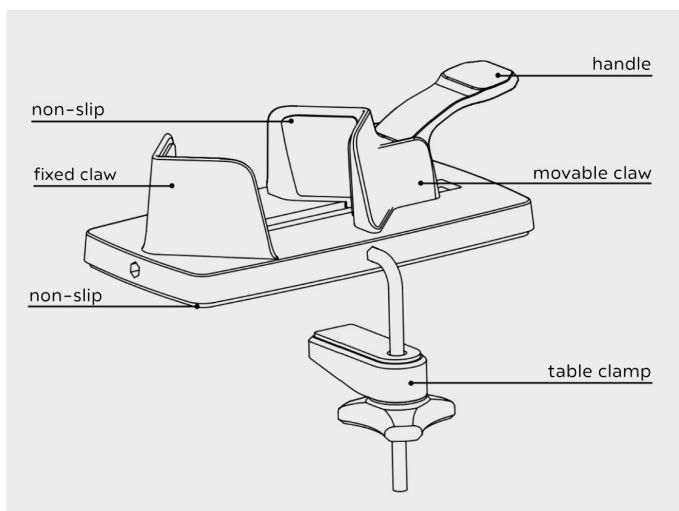
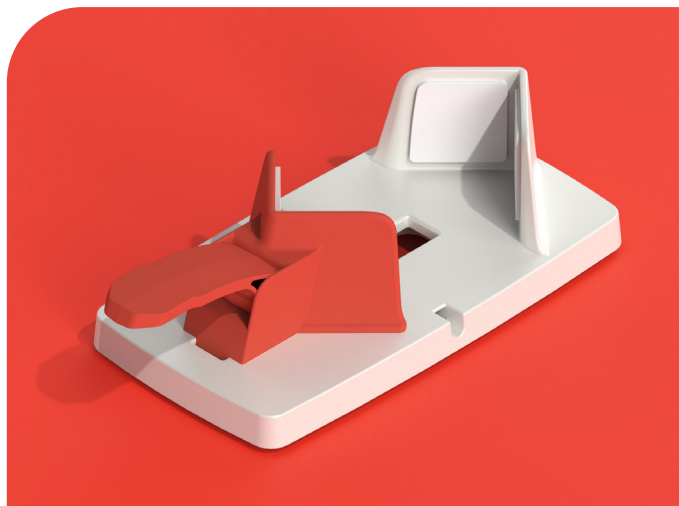

OPEN



SLIDING MECHANISM



LOCKED WITH PRODUCT



Theomatik®

Theomatik® is an innovative tool designed to **help people who can only use one arm eat independently**, both at home and on the go. Allowing people to eat without assistance boosts their independence and self-esteem, making the process easier and more enjoyable.

The product is designed with an ergonomic focus to stimulate fine motor skills, which is essential for older adults and those in rehabilitation. Its tactile and sensory features are important, and the orange color was chosen for its visual support for people with visual impairments or dementia.

In addition to **restoring independence and dignity**, Theomatik® also **reduces the workload of caregivers**, allowing them to focus on other tasks. It offers value to users while also providing a solid return on investment for care institutions like hospitals and nursing homes.

The Theomatik® assistive lunch plates are **stackable**. They were specially designed for easy stacking with a focus on **optimal space utilization**. The plates also contain **conical openings** intended to hold jars or packagings with a diameter ranging from **20 to 70 mm**.

SPECIFICATIONS

- ↔ Measurements (L x W x H): 36,5 x 18,8 x 3 cm
- 🛒 Weight: 900 g
- 📄 Durable and dishwasher-safe
- 🔍 Material: Polypropylene, TPE, Stainless steel, BPA-free

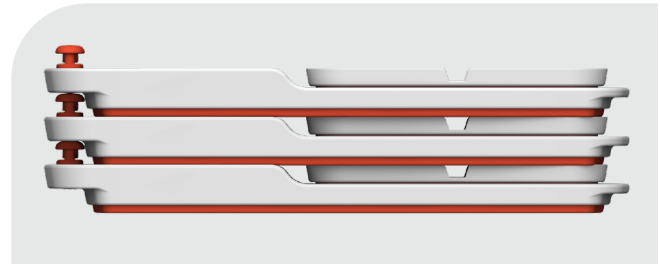

Reference code	Description	Unit	📄
15-050103	Theomatik	1 pc	BE

Packaging cutter:

Small, safe cutting tool to open all types of packaging and bags. E.g. sugar, tea, cheese, or ham, all with one hand.

Anti-slip:

Non-slip underside that ensures stability on tables and trays, making it easier to open jars or cut bread without the tray moving.

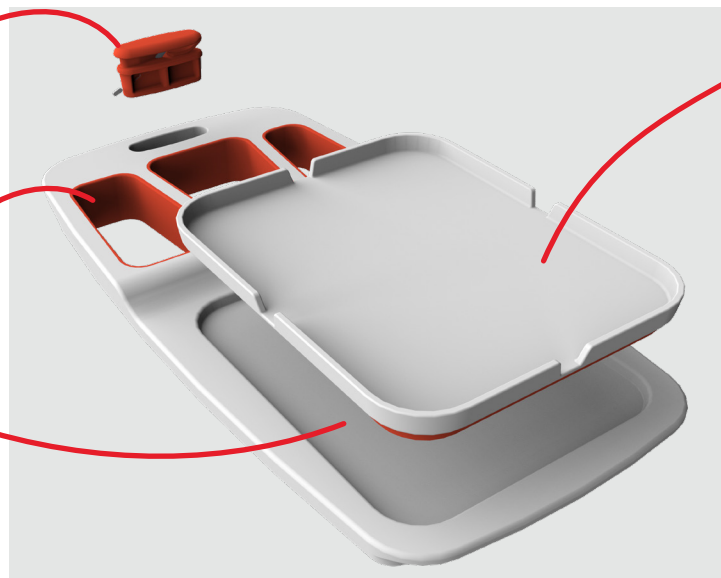

Small lunch plate:

Allows you to secure a sandwich between its four raised edges. It has a non-slip base and features pre-shaped cutting guides on the sides, making it easy to slice your sandwich.



HENRY VAN
DE VELDE
AWARDS



Private label



Do you want to work together?

You like our products, but you would like your own brand or your customer's name on one or more of them? **Let's work together!**

In close collaboration with our manufacturers from all the products in our range, we can create your desired product with the exact look you want. We can **replace our logo with yours, change the colour, even the packaging** can be tweaked to your needs and liking. Private labels will allow you to design the product the way you want to match it to your company's or customer's identity.

Private Label products are identical in quality as all our products, with the benefit of putting **your brand in the spotlights**. Looking for the perfect solution to a homogeneous range of products? Want to increase your brand awareness? Need a one time opportunity, such as a promotional product? We'll take care of it.

Please **contact us** for more information about pricing and volume.
sales@mvs-in-motion.com

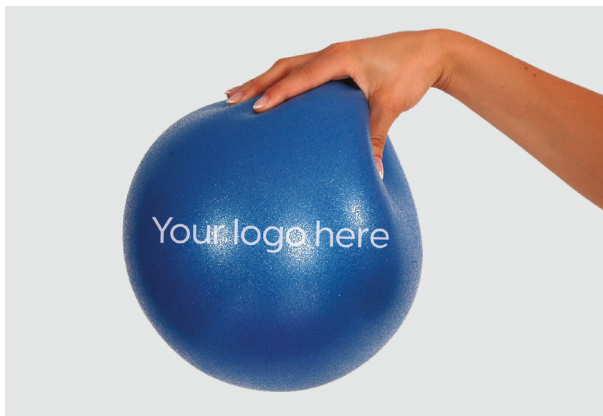

Product description	Minimum order quantity
Fabric loops	500 sets of 3
Set of 4 loops	50 sets of 4
Loops (10-pack)	50 units per colour
Superloop	50 units per colour
Band	50 units per colour
Soft-over ball	1000 units per colour
AB gym ball	300 units per colour
Yoga mat	300 units
Xtra comfort gym mat	300 units
Hollow foam roller	300 units
Various other products	Contact us for more info

After-sales



MVS In Motion calibration service

Measurement Instruments are calibrated at manufacturing with a full one year guarantee, before sending them to users all over the world. Ideally, these instruments should be recalibrated every year.

In order to make this happen in an easy and inexpensive way, Hydraulic Hand Dynamometers (Saehan, Baseline, ...) and Hydraulic Pinch Gauges are recalibrated by our experts at the MVS In Motion Centre in Roeselare - Belgium. This operation consists of re-establishing the exact relationship between the force applied to a dynamometer and the measurement it shows. Small repairs can be done as well.

Simply send your request to our customer service department for a return authorisation. After each recalibration, you will receive an updated calibration certificate, certifying accurate and repeatable test results.

If you have many calibrations to do, you might consider buying your own calibration unit.



Reference Code	Description	Unit
08-019901	Calibration Unit	1 pc
08-019900	Calibration & Repair	-

MVS In Motion repair centre

Since machines are designed and assembled by humans, they are not flawless. That is why MVS In Motion installed an inhouse repair centre, to swiftly and correctly solve any problems that may occur with our products.

No matter the cause, be it faulty fabrication or misuse, our technician will shine his light on the problem.

Send an email to our customer service department to inform us on the type of problem and the serial number / production date of the device. After our authorisation, please send over the patient, accompanied by your name and client number and a brief description of the symptoms to aftersales@mvs-in-motion.com. We'll do our best to have it **cured in no time!**



Terms & Conditions



Article 1. Company details

These sales conditions apply to all current and future agreements with MVS IN MOTION BV, with registered office at 8800 Roeselare, Krommebeekpark 11 and registered with the RPR Gent, Division Kortrijk under number O458.496.729 (hereinafter referred to as "MVS"), as well as with any company affiliated to MVS in accordance with Article 120 of the Companies and Associations Code.

Article 2. Applicability

These conditions are applicable to all offers, all agreements, all purchases and orders, both made in MVS's office and online, by e-mail or any other medium (hereinafter generally referred to as "Agreement(s)"). As soon as the customer (hereinafter referred to as "Customer(s)") enters into an Agreement with MVS, it accepts the general conditions as described in this document to the exclusion of the application of any of its own general conditions, even if these contain the same grounds for exclusion. The General Terms and Conditions are applicable to all products and services offered by MVS, except in the case of an explicit deviation which is the result of mutual agreement and written confirmation. Explicit deviations shall only be valid as a replacement or an addition to the clauses to which they relate. The other provisions of these general terms and conditions shall continue to apply in full. If a provision contained in these general terms and conditions is contrary to an international treaty, insofar as it is applicable, a law, regulation or other mandatory regulation, the provision in question shall not apply. The invalidity of a provision shall not affect the validity of the remaining provisions of the general conditions, which shall continue to apply in full. MVS reserves the right to change and/or to supplement the general conditions at any time. An amendment of these general conditions shall have no effect on already existing Agreements. Any matters not explicitly provided for in these general terms and conditions of sale shall be governed by the provisions of Belgian law.

Article 3. Conclusion of the Agreement

Anyone placing an order confirms that they are commercially competent. Commercially incompetent persons shall be represented by their legal representative, who shall also be bound by these general conditions. MVS undertakes to process orders as long as stocks last and within the limits specified in these general conditions. The order can only be processed when the Customer has clearly identified himself. The placing of an order shall constitute acceptance of these general sales conditions. Placing an order entails an obligation to pay. The general conditions are always available and can be consulted on the website. MVS reserves the right to refuse orders in case of serious suspicion of abuse of rights or bad faith, serious suspicion of commercial purposes unacceptable to MVS or in case of exhaustion of stock of a certain article. For each order, the general terms and conditions that are included on the website and/or on the invoice are applicable. The language of the Agreements concluded is English. An order is only final after acceptance of these general terms and conditions, the prices and the description of the offer. If anything is unclear in the offer or after ordering, the Customer can always contact us, either via info@mvs-in-motion.com or by telephone between 9 a.m. and 5 p.m. on +32 51 50 55 01.

Article 4. Signature and proof

The Customer accepts electronic evidence. The Customer is solely responsible for the accuracy of all the data he or she transmits. The final confirmation of the order by the Customer is deemed to be acceptance of the order at the price set.

Article 5. Prices and Payment

The prices are ex works Roeselare (EXW), Belgium. All prices of products are indicated in Euros and are exclusive of VAT. Shipping costs, transport costs, bank charges, delivery costs, taxes and other levies are not included in MVS' prices and will be paid by the Customer, unless otherwise agreed in writing. For orders with an order value of less than 250 € an administrative cost of 10 € will be added. The Customer owes MVS the price that was indicated in the confirmation of the delivery note. Obvious errors in the price quote, such as evident inaccuracies, can be corrected by MVS even after the conclusion of the agreement. All offers made by MVS are free of obligation. MVS can change prices at any time without prior notification. In the absence of timely or full payment, default interest of twelve percent (12%) per year will be owed, ipso jure and without notice of default, from the due date of the invoice until the day of full payment. In the event of non-payment, late payment or full payment, a fixed compensation amounting to 15% of the invoice amount, costs included, with a minimum of EUR 40 will also be payable. In case of non-timely payment of an invoice, all other claims of the Customer that have not yet fallen due will become immediately due by operation of law. With non-payment, MVS reserves the right not to deliver the products. MVS also reserves the right to regard the sales agreement as dissolved by operation of law and without prior notice of default, for the whole or the part not yet executed.

Article 6. Delivery of the Order

Products will only be delivered in the countries for which MVS allows delivery. The chosen delivery option influences the delivery period. The stated delivery times are not binding, but are given merely as an indication. Incorrectly communicated delivery addresses are the responsibility of the Customer and may result in additional costs. MVS is entitled to make partial deliveries. The Customer is responsible for all additional taxes and duties. MVS cannot be held responsible for any fees charged by a third party. The delivery will be at the risk of the Customer. No delay in delivery can lead to the termination of the agreement, except in case of deliberate delay. MVS commits to pack the products to be delivered as carefully as possible in order to exclude the possibility of damage during normal handling. MVS accepts no responsibility for late deliveries due to unforeseen circumstances caused by third parties, nor for loss, theft or damage during shipment by third parties and, insofar as permitted by law, MVS shall also not be liable for losses, costs, liability, damages, fines or expenses caused by a delay or failure to deliver due to unforeseen circumstances caused by third parties, nor for loss, theft or damage during shipment by third parties.

Article 7. Reservation of Ownership

The ownership of products will only be transferred to the Customer after full payment of all sums due by the Customer to MVS, including payment of the agreed price, costs, interest and possible damages. Until the actual transfer of ownership, the Customer is prohibited from reselling, renting out, pledging, processing, incorporating or in any other way disposing of or encumbering the products until all payments and obligations have been fully settled, unless otherwise agreed by MVS. Nevertheless, the Customer shall bear the risk of loss or destruction of the Products from the moment of delivery.

Article 8. Force Majeure

MVS will not be responsible for delays in the fulfilment or non-fulfilment of its commitments due to events beyond its normal control, including production interruptions, difficulties in acquiring or shortages of raw materials, work force, energy or transport or delays in transport, strikes, epidemics, pandemics, lock-outs, work interruptions or other collective labour disputes, which affect either MVS or its suppliers, disruptions in the internet, the electricity network, mail traffic or technology provided by third parties, government measures and illness, even if these events are foreseeable.

Article 9. Intellectual Property Rights

All intellectual property rights and derived rights are retained by MVS. These intellectual property rights include copyrights, trademark rights, drawing and model rights and/or other (intellectual property) rights, including patentable or non-patentable technical and/or commercial know-how, methods and concepts. The contents of the website, images, logos, drawings, photos, data, product names, texts, etc. are protected by copyright and other (intellectual) property rights and treaty provisions, which exclusively belong to MVS. The photographic work of MVS is subject to copyrights, which are exclusively retained by MVS. For use for commercial purposes, the Customer must request permission and/or pay a fee to MVS.

Article 10. Processing of Customer Data and Privacy

When products are purchased, the Customer explicitly agrees that his or her personal data can be used and processed for administrative purposes, such as keeping track of orders in a customer database or for billing purposes. The information provided by the Customer is necessary for the processing and completion of orders and invoicing. If these data are missing, the order will inevitably be cancelled. Personal data will only be processed for promotional purposes, personal advertising and/or other (re)marketing purposes if the Customer has given his/her consent. MVS will never pass on this personal information to third parties, unless with the Customer's consent or when explicitly requested by judicial authorities or when it is legally obliged to do so. The Customer has the right to modify or review his or her personal information at any time. The Customer also has the right to oppose, free of charge, the processing of his personal data for direct marketing initiatives. Only Customers who have given their express consent to this will be included in MVS's newsletter. Unsubscribing is possible upon simple request of the Customer. Should the Customer wish to contact MVS with regard to the processing of his or her personal data, a message should be sent to the following e-mail address: info@mvs-in-motion.com

Article 11. Defects and complaints

The Customer undertakes to examine the products thoroughly immediately upon receipt. MVS' warranty is limited to the warranty for hidden defects and the warranty in the case of consumer purchases, both as specified in the Civil Code. MVS is only responsible for damages which are the result of intent or gross error. MVS is not responsible for general or special indirect damages of any kind suffered by the Customer nor for damages to goods, visible at delivery, which are not mentioned on the carrier's consignment note. MVS shall also not be responsible for any postponement or cancellation of a production that is due to late delivery by the Customer or its subcontractor of a product or accessory, or to the punctuality or faulty conduct of the latter. Complaints must reach MVS in order to be admissible: (a) in the case of complaints due to non-conformity of the delivery, seven (7) days after delivery and (b) in the case of hidden defects, seven (7) days after discovery of the defect or after the moment by which such discovery could reasonably have taken place. The acceptance of the goods by the Customer covers any possible defect or non-conformity which could have been discovered at that time. MVS undertakes to answer the complaint within a period of 14 calendar days after written receipt. Reimbursement or exchange are only possible after explicit agreement by MVS. Prior to the return of the products, the Customer will provide MVS with a detailed inventory of the products that will be returned (cfr Complaint Form) as well as any other information that MVS may require, including but not limited to the batch number, the production date or the expiry date. Under no circumstances will returns of more than 30 days after delivery be accepted, nor will returns be accepted for products that are damaged, used or not in their original and unopened packaging. In the event of a return, MVS may charge the Customer a processing fee of ten percent (10%) of the purchase price (costs and taxes included).

Article 12. Applicable law and competent court

All offers and Agreements are governed exclusively by Belgian law. In the event of disputes, the courts of the judicial district of Gent shall have jurisdiction. Within the framework of their relations, the parties concerned accept electronic evidence.



MVS In Motion | Krommebeekpark 11, 8800 Roeselare | Belgium - Europe
+32 51 50 55 01 | www.mvs-in-motion.com | info@mvs-in-motion.com